



HUME DOORS & TIMBER



2022

PRODUCT CATALOGUE

2022-July Version 1.0



WELCOME TO HUME DOORS & TIMBER



"When you are designing a space it is the attention to every detail that elevates a space from every day to an experience. The doors you select can have a huge impact on how people transition from one space to another, as well as how the spaces integrate.

They consolidate the style of your home and provide a quality experience both in touch and sight."

- Naomi Findlay

NAOMI FINDLAY

Creating healthy, wealthy & beautiful spaces.

HUME'S VALUES

- To innovate and make a difference in your home
- To continue to build valued relationships with staff, suppliers and distributors
- To continue to improve on our environmental sustainability and recycling

Hume Doors & Timber is the nation's largest 100% Australian owned timber door manufacturer with over 60 years of proud history. Hume Doors will always stand by its family based values and exceptional customer service.

Whether leading the way in sustainability, innovation or design, Hume Doors & Timber remains committed to developing outstanding products for the Australian market.

Hume Doors & Timber complies with Australian Standard AS 2688-2017 for the manufacture and importation of timber doors.



Scan QR code to view our 60 year history video



CONTENTS

ENTRANCE DOORS

8-9	Haven
10	Savoy 1200
11	Verve
12-13	Savoy 820
14-15	Linear
16-17	Joinery
18	Illusion
19	Vaucluse
20-21	Newington
22	Regency
23	Nexus
24-25	Vaucluse Premier
26	Carringbush
27	Glass Opening

ENTRANCE SYSTEMS

28	Alfresco Multifold
29	Pivot Frames
30	Standard Frames
31	Weatherguard Frames

BUSHFIRE RESISTANT DOORS & FRAMES

32	BAL (Bushfire Attack Level)
32	BAL12.5 Doors & Frames
33	BAL19 & 29 Doors
34	BAL40 Doors
35	BAL19 & 29 Merbau Weatherguard Frames
36	BAL40 Merbau Weatherguard Frames

INTERNAL BARN DOORS

37	Frontier Track System
38	Frontier Standard Barn Doors
39	Frontier Ultimate Barn Doors

INTERNAL DOORS

40-41	Hampton
42-43	Humecraft
44	Sorrento
45	Joinery
46-47	Linear

INTERNAL DOORS

48	Accent
49	Strata
50	Moulded Panel Woodgrain Skin
51	Moulded Panel Smooth Skin

INTERNAL SYSTEMS

52	Cavity Units
53	Cavity Units Additional Extras
53	Evolution Premium
54-55	Smartrobe
56	Bi-Fold
57	Multi-Fold
58	Prehung

FLUSH DOORS

59	Honeycomb Core
59	Solicore (SCX1)
59	Blockboard (STPC)

HUME COMMERCIAL

60	Steel Door Frames
61	Elite Aluminium Doors
61	Fire Doors

GLASS

62-63	Glazing Options
-------	-----------------

TIMBER

64	Fibre-Cement Products
65	Timber Mouldings Profiles

EXTRAS

4	Environmental
5	Construction Types
6-7	Style Guide
66	Guarantee Doors
66	Steel Door Frame Warranty
67	Overhead Protection
67	Care & Maintenance
68	Contact Details

Key for Specifications tables

	Door Construction Type	Denotes the type of door construction. For more information go to page 5
	Door Sound Rating	Door sound rating. Refer to our website for further information: www.humedoors.com.au/downloads
	Bushfire Attack Level	Bushfire Attack Level Rating. For more information go to page 32
	Weight	Door weight in kg



ENVIRONMENTAL COMMITMENT

Hume Doors & Timber is committed to operating its entire business processes in an environmentally sustainable manner at all times. Our goal is to be regarded as an environmentally responsible corporate citizen that practices environmental stewardship and provides our valued customer base with complete confidence that our products have been produced in accordance with applicable independent environmental standards.

- Reusing and recycling by-products, packaging and waste material
- Reducing the level of packaging and consumables used
- Capturing, storing and using rainwater for our water needs
- Maximise transport loads, thus reducing energy requirements

We embrace environmental awareness, protection and enhancement.

Timber is a fully sustainable resource that is non-toxic, reusable and versatile. The continued growth and planting of forests aid in the reduction of carbon dioxide. The future of our products, business, industry and customer satisfaction is directly linked to the sustainable management of the world's forests.

Our manufacturing and distribution processes have been designed to minimise our environmental footprint by, among other things:

- Utilising energy to its maximum efficiency
- Subscribing to renewable energy sources (where possible)
- Utilising recycled product (where possible)
- Organising our transportation routes to minimise energy requirements of our vehicle fleet
- Providing reliable, long lasting products that are backed by a 5 year guarantee
- Ensuring our suppliers of raw material products are accredited by appropriate independent, third party environmental stewardship programs including FSC (Forest Stewardship Council), PEFC (Programme for the Endorsement of Forest Certification Schemes), AFS (Australian Forestry Standard), etc and hold to the principles of and guidelines contained within these programs.



The mark of responsible forestry

FSC® CERTIFICATION

Hume Doors & Timber (Aust) Pty Ltd is a certified member of the Forest Stewardship Council® (SGSHK-CoC-009377)



The mark of responsible forestry

FSC® CERTIFICATION

Hume Doors & Timber (Qld) Pty Ltd is a certified member of the Forest Stewardship Council® (SGSHK-CoC-009405)



PEFC™ CERTIFICATION

Hume Doors & Timber (Aust) Pty Ltd is a member of the Programme for the Endorsement of Forest Certification Schemes (AU17/05236)



<p>Engineered Joinery</p> <ul style="list-style-type: none"> STILES AND RAILS INFILL PANEL: Glass or Solid Infill FACE MATERIAL: Selected face material BOTTOM RAILS 	<p>Solid HMR MDF Core (DB)</p> <ul style="list-style-type: none"> STILES AND RAILS CORE: Medium density fibreboard core. Moisture resistant (HMR MDF) FACE MATERIAL: Selected face material RAILS: Bottom rail 	<p>Honeycomb Core (Hollowcore X1)</p> <ul style="list-style-type: none"> STILES AND RAILS CORE: High Density cellular core LOCK BLOCK FACE MATERIAL: Selected face material 	<p>Solicore Particleboard Core (SCX1)</p> <ul style="list-style-type: none"> STILES AND RAILS CORE: Particle board core highly moisture resistant FACE MATERIAL: Selected face material
<p>BAL 40 Construction</p> <ul style="list-style-type: none"> TOP RAIL: 18mm Hardwood STILES: 32mm Meranti CORE: (TVC) Vermiculite Core FACE MATERIAL: Selected Face Material BOTTOM RAIL: 32mm Meranti 	<p>Frontier Premium Hollow Core (SG)</p> <ul style="list-style-type: none"> RAILS: 180mm top rail STILES LOCK BLOCK CORE: Maximum Density cellular core FACE MATERIAL: Selected face material double thickness 	<p>Frontier Ultimate Solid Infill Core</p> <ul style="list-style-type: none"> RAILS: 180mm top rail STILES INFILL PANEL: Solid Infill FACE MATERIAL: PCMDF for paint 	<p>Door Stiffener (HMR MDF)</p> <ul style="list-style-type: none"> 32mm STILES & RAILS Reinforced with metal stiffeners CORE: Medium density fibreboard core moisture resistant (HMR MDF) FACE MATERIAL: Selected face material
<p>Hampton Construction</p> <ul style="list-style-type: none"> STILES & TOP RAIL INFILL PANEL: Solid Infill FACE MATERIAL: Pre-primed Face Material BOTTOM RAIL 	<p>Honeycomb Core (Hollow Core H1)</p> <ul style="list-style-type: none"> STILES AND RAILS CORE: High Density cellular core LOCK BLOCK FACE MATERIAL: Selected face material 	<p>Solid HMR MDF Core (HV)</p> <ul style="list-style-type: none"> STILES AND RAILS CORE: Medium density Fibreboard core. Moisture resistant FACE MATERIAL: Selected face material RAILS: Bottom rail 	<p>Honeycomb Core (Hollowcore SG) 6mm Skin</p> <ul style="list-style-type: none"> STILES AND RAILS CORE: Maximum Density cellular core LOCK BLOCK FACE MATERIAL: Selected face material double thickness (6mm Skin)
<p>Honeycomb Core Large Cell (Hollow Core Moulded Panel)</p> <ul style="list-style-type: none"> STILES AND RAILS CORE: High Density cellular core LOCK BLOCK FACE MATERIAL: Moulded Panel 	<p>Solicore Particleboard Core (SCX1 Moulded Panel)</p> <ul style="list-style-type: none"> STILES AND RAILS CORE: Particle board core highly moisture resistant FACE MATERIAL: Moulded Panel 	<p>Solicore Particleboard Core (SCX1 PCMDF)</p> <ul style="list-style-type: none"> STILES AND RAILS CORE: Particle board core highly moisture resistant FACE MATERIAL: Pre-primed Face Material 	<p>Solid Timber Pine Core (STPC Blockboard)</p> <ul style="list-style-type: none"> CORE: Timber (kiln dry) blockboard core FACE MATERIAL: Selected face material



STYLE GUIDE

Welcome to our style guide. In this space, we've brought together design ideas to help you unlock your creativity and make inspired door selections that will turn your house into your dream home.

Now you can easily navigate our catalogue for the perfect doors to suit your vision for your home.

Look throughout the catalogue for the style icon under the name of each range.



MODERN M

Mid-Century | Box Modern

Modern design encompasses five key architectural styles. Mid-century Modern, Box Modern, Natural Contemporary and Mixed-Material. Clean lines, clever use of materials, geometric shapes, open floor plans, large glass windows, and flat roofs.

- Clean lines
- Large glass windows
- Open floor plans
- Clever mix of materials



SCANDI S

Minimalist | Urban Luxe

The Scandi style is the hot trend of the moment. Inspired by the country-style Gustavian interiors from Sweden, the Scandinavian Modernist Minimalist movement or the Danish passion for Hygge, we can't seem to get enough of it.

- Light & bright
- Clean design
- White colours & natural timbers
- Comfy & cosy





STYLE GUIDE

HAMPTONS H

Elegant | Coastal | Seaside Retreat

This style mixes elements of coastal, country and modern design seamlessly. The key is light colours such as white, off white and light grey, horizontal cladding, a large verandah, a traditional or modern front door and plenty of greenery in the gardens.

- Inspired by holiday homes
- Contrasting Lines
- Pastel colours
- Light & breezy



INDUSTRIAL I

New York Inspired | Contemporary

The industrial look, once reserved for a super cool New York-style loft or warehouse conversion, is now becoming increasingly popular in contemporary home design. Makes use of rustic and recycled materials that focus on textures.

- Exposed structures & straight lines
- Metal & brickwork
- Raw & neutral
- Clever storage solutions



CLASSIC C

Traditional | Provincial

This style mixes traditional elements from the home's past with modern design. Typical Traditional and Provincial architecture comes from the 18th and 19th centuries and includes Federation, Colonial, Victorian & Edwardian styles.

- Timeless
- Decorative & substantial
- Rich with character
- Structured & balanced





ENTRANCE DOORS

HAVEN

H

The Hamptons Inspired Entry Range



The Haven Range has the perfect coastal-inspired classic Hamptons look, with large French styled glass panels that let in an abundance of natural light. The quintessential Hamptons design style of the Haven creates a relaxed, welcoming and beachy feel



ENTRANCE DOORS

HAVEN



HAV22



HAV44



HAV45



HAV66



HAV67



HAV88



HAV89



HAV99



HAV100



V-Groove option

Face Options

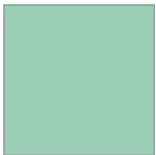

DuraXP (standard)



SPM

- Standard Door Size: 2040x820x40
- Custom Door Size: Min 1990x805x40 - Max 2400x1200x40
- Standard Sidelite Size: 2040x400x40
- Custom Sidelite Size: Min 1990x330x40 - Max 2400x500x40
- Rout: Standard both sides
- V-Groove: Optional for all designs

Glass Options



Clear



Cathedral



Grey Tint



Translucent

Specifications

	Solid HMR MDF Core (DB)		
	Unglazed (HAV22 only)	Rw:30	STC:29
	Glazed	Rw:31	STC:31
	BAL12.5		
	40kg		



ENTRANCE DOORS
SAVOY 1200

M I

Grand & Stunning

The Savoy 1200 range is engineered using joinery construction techniques featuring veneered laminated timber stiles and rails. Designed from choice timbers with a variety of glass options to suit your custom style.



XS24



XS26



XS28



XS45

Face Options

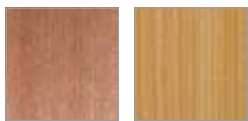

SPM (standard)

Tassie Oak

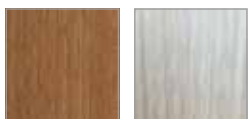

Merbau

Blackbutt

Glass Options



Clear

Cathedral

Grey Tint

Translucent



Africana

Low E

Geostep

Rice Paper

Specifications

	Engineered Joinery	
	Rw:29	STC:30
	BAL12.5	
	48kg	

- Standard Door Size: 2040x1200x40, 2340x1200x40
- Custom Door Size: Min 1990x1100x40 - Max 2400x1200x40



ENTRANCE DOORS

VERVE

M S I

Sophisticated, Crisp & Neat

Designed with refined glass panels and a sleek contemporary design, the Verve range has been enhanced with the ability to create unlimited designs from an extensive glass range.



VER1



VER4



VER6



VER11

Face Options



DuraXP (standard)

SPM

Tassie Oak



Merbau

Blackbutt

Glass Options



Clear

Cathedral

Grey Tint

Translucent



Geostep

Low E

Rice Paper

Specifications

	Solid HMR MDF Core (DB)	
	Rw:31	STC:31
	BAL12.5	
	40kg	

- Standard Door Size: 2040x820x40
- Custom Door Size: Min 1990x805x40 - Max 2400x1200x40



ENTRANCE DOORS
SAVOY 820

M H I C

Stunningly Eye Catching

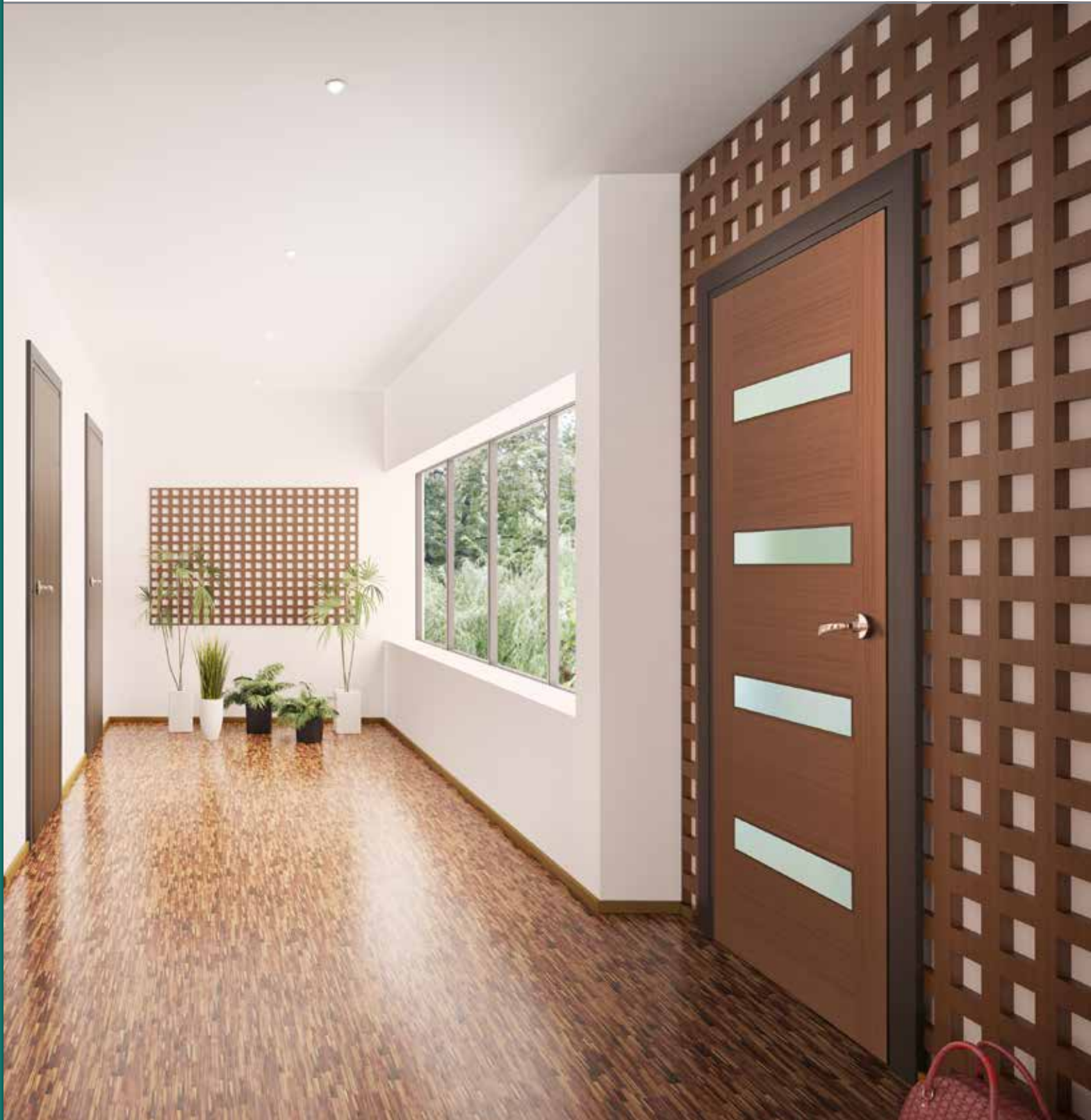

The Savoy 820 range is engineered using joinery construction techniques featuring veneered laminated timber stiles and rails. Designed from choice timbers with a variety of glass options to suit your custom style.



ENTRANCE DOORS SAVOY 820

M H I C



XS2



XS3



XS4



XS11

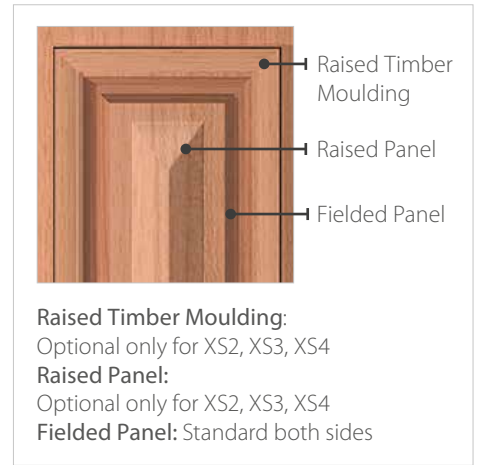

XS24



XS26



XS28



XS45

Specifications

	Engineered Joinery	
	Rw:29	STC:30
	BAL 12.5	
	30kg	

Face Options



SPM (standard)

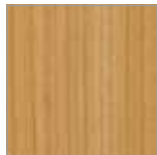

Tassie Oak
(XS11, 24, 26, 28, 45)



Merbau
(XS11, 24, 26, 28, 45)



Blackbutt
(XS11, 24, 26, 28, 45)

- Standard Door Size:
2040x820x40
- Custom Door Size (XS11, XS24, XS26, XS28, XS45):
Min 1990x805x40 - Max 2400x1100x40
- Standard Sidelite Size:
2040x400x40

Glass Options



Clear



Cathedral



Grey Tint



Translucent



Africana



Low E



Geostep



Rice Paper

■ For more glass designs refer to Glazing Options table on page 62



ENTRANCE DOORS

LINEAR



Striking, Unique & Stylish



Allow the natural beauty of timber to enrich your home or opt for a modern and fresh painted look with the Linear range of doors. Inspired by contemporary European trends, these striking designs will add a unique style to any home.



ENTRANCE DOORS LINEAR

M S I



XLR120



XLR130



XLR140



XLR150



XLR160



XLR170



XLR300



XLR310



XLR500



XLR600



XLR700



XLR500 (1200)

Face Options

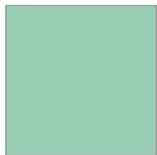

DuraXP (standard)
XLR120, 130, 140, 170,
700



SPM (standard)
XLR150, 160, 300, 310, 500, 600

- Standard Door Size: 2040x820x40, 2040x1200x40
- Custom Door Size: Min 1990x805x40 - Max 2400x1200x40
- Rout: Both sides
- Not suitable for rebated pairs
- Alignment of horizontal rout is not guaranteed for pairs

Specifications

	Solid HMR MDF Core (DB)	
	Rw:30	STC:29
	BAL12.5	
	40kg (820mm)	58kg (1200mm)

Glass Options



Clear



Cathedral



Grey Tint



Translucent



Africana



The Joinery range is where modern functionality and classical style collide. Crafted from select timbers and available with a wide variety of glass options, this range features an engineered joinery construction system, pairing modern techniques with traditional methods.



ENTRANCE DOORS JOINERY



JST1



JST11



JST1 (1200)



JST4



JST12



JST2



JST6



JST10



JST5



XL10

- Standard Door Size:
2040x620/720/770/820x40 (JST1, JST10)
2040x1200x40 (JST1)
2040x720/820x40 (JST4, JST6)
2040x820x40 (JST2, XL10)
- Custom Door Size:
Min 1990x805x40 - Max 2400x1200x40 (JST1, JST2)
- Standard Sidelite Size:
2040x400x40 (JST5, JST11, JST12)
- Custom Sidelite Size:
Min 1990x330x40 - Max 2400x500x40 (JST11)

Face Options



SPM
(standard)



Tassie Oak
JST1, 11, 2



Merbau
JST1,11, 2



Blackbutt
JST1, 11, 2

Specifications

	Engineered Joinery	
	Rw:29	STC:30
	BAL12.5	
	30kg	

Glass Options



Clear



Clear Laminated



Cathedral



*Double Glaze
Clear



Grey Tint



Translucent



Africana



*Double Glaze
Frost



Low E



Geostep



Rice Paper

- *Double Glazed is only available for 2040x820x40 JST1 doors
- JST1 Clear Glazed comes with safety decals on glass



ENTRANCE DOORS
ILLUSION

M I

Bold, Individual & Dreamy

It's all in the name with the Illusion range. These doors appear to have inserts that float, allowing an abundance of natural light to enter your home. With options of Clear, Frost, Grey or Africana glass, this range leaves a spectacular impression.



XIL1



XIL6



XIL21



XIL26

Specifications

	Engineered Joinery	
	Rw:29	STC:30
	BAL12.5 (Laminated Glass Only)	
	30kg (820mm)	48kg (1200mm)

- Standard Door Size: 2040x820x40, 2040x1200x40
- Custom Door Size: Min 1990x805x40 - Max 2400x1200x40
- Sidelite option refer to Joinery Range (JST11) page 17



TIMBER PANELS BOLTED
For all standard size doors premium stainless steel bolts are used to secure timber floating panels (excludes translucent glazing option).



TIMBER PANELS GLUED
For all custom sizes & translucent glazing options timber floating panels are glued to glass. Timber floating panels remain the same size.

Face Options



SPM

Glass Options



Clear



Grey Tint



Frost



Africana



Translucent



ENTRANCE DOORS
VAUCLUSE
 M S I C

Craftsmanship & Simplicity

The Vaucluse range offers a variety of modern and unique designs to match any architectural frontage. A smooth internal face and definitive carvings to the external side makes for a simple, yet stunning addition to any facade.



NOTE: Vaucluse doors are routed on external face only as standard. Door shown has rout design on both sides as an optional extra.



XV1

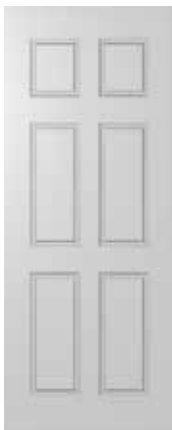

XV4



XV9



XV10



XV14

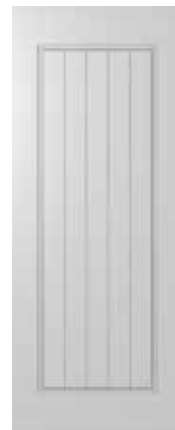

XV18



XV20

Face Options



DuraXP
(standard)

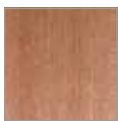

SPM

Specifications

	Solid HMR MDF Core (DB)	
	Rw:30	STC:29
	BAL12.5	
	40kg	

- Standard Door Size: 2040x820x40
- Custom Door Size: Min 1990x805x40 - Max 2400x1200x40
- Rout: One side as standard. Double sided rout available as an optional extra
- Sidelite option refer Newington (XN9 & XN14) page 21



ENTRANCE DOORS

NEWINGTON



Popular, Attractive & Versatile

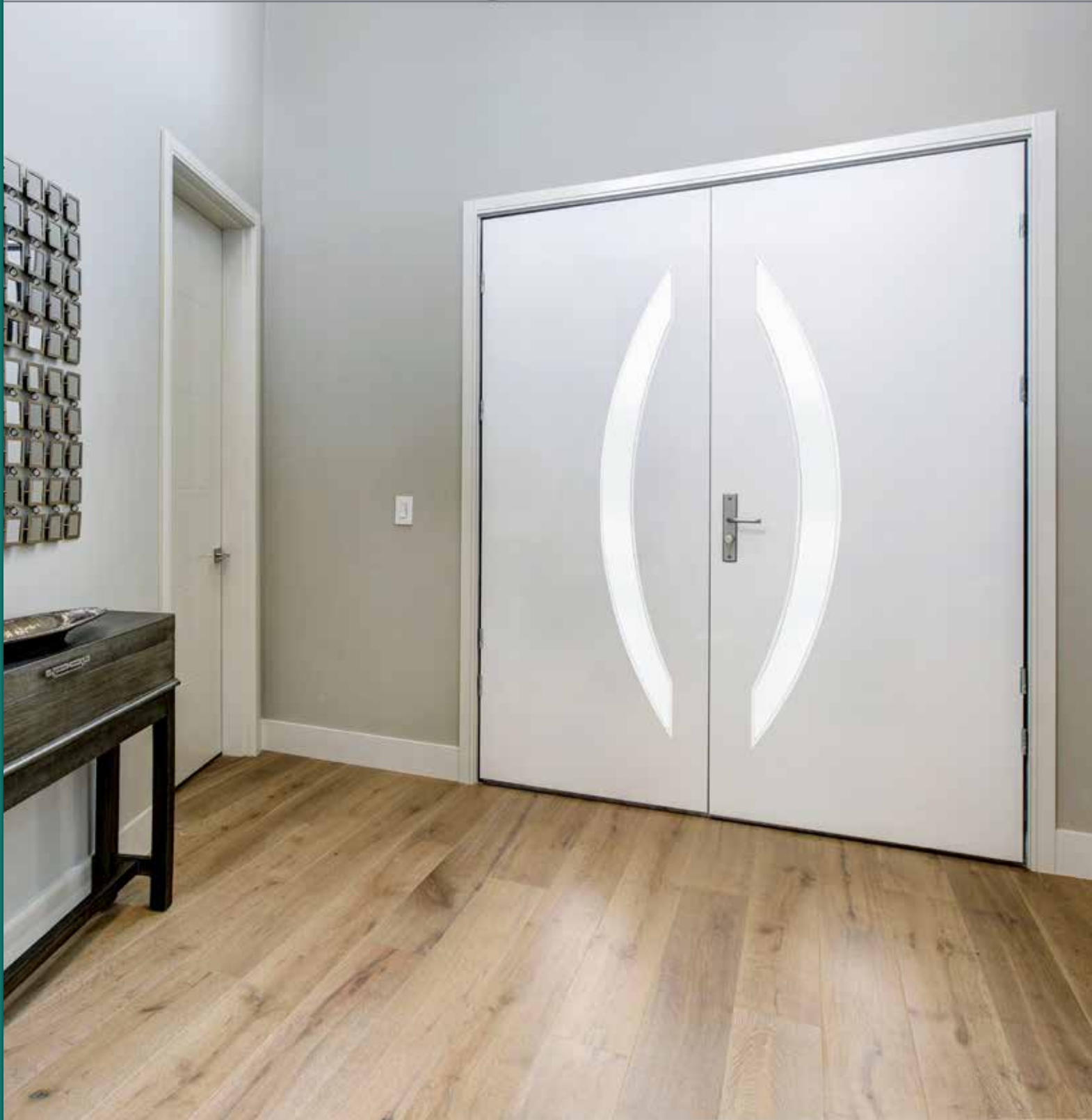

The Newington range offers a highly sought-after and timeless design, with unrivalled adaptability and style. Choose from an array of stunning designs, glass and sidelites to create a bespoke look perfect for your home.



ENTRANCE DOORS NEWINGTON



XN1



XN5



XN11



XN6



XN12



XN7



XN9



XN14



XN16

- Standard Door Size: 2040x820x40
- Custom Door Size: Min 1990x805x40 - Max 2400x1200x40
- Standard Sidelite Size: 2040x200x40 (XN14) 2040x400x40 (XN9, XN11, XN12)
- Custom Sidelite Size: Min 1990x330x40 - Max 2400x500x40
- Tassie Oak / Merbau / Blackbutt not available for XN6 & XN12
- Millenium Slumped glass not available for XN6 & XN12

Face Options



DuraXP (standard)



SPM



Tassie Oak







Merbau



Blackbutt

Specifications

	Solid HMR MDF Core (DB)	
	Rw:31	STC:31
	BAL12.5	
	40kg	

Glass Options



Clear



Cathedral



Grey Tint



Translucent



Millenium Slumped



Africana



Low E



Geostep



Rice Paper



ENTRANCE DOORS
REGENCY



Supreme & Classic

Complement any classically styled home with the Regency range of doors. These custom designs offer deep routed patterns to both door faces and beautifully timeless timber mouldings to the exterior face. These solid core doors offer a selection of glass options, including triple-glaze leadlight.



XR4



XR4 (1200)



XR5



XR6

- Standard Door Size:
2040x820x40, 2040x1200x40
- Custom Door Size:
Min 1990x805x40 - Max 2400x1200x40
- Standard Sidelite Size:
2040x400x40
- Custom Sidelite Size:
Min 1990x330x40 - Max 2400x520x40
- Rout: Both sides as standard
- Moulding: Standard on external face only. Option for both sides

Face Options



DuraXP (standard)

SPM

Glass Options



Clear

Cathedral

Grey Tint



Translucent

Africana

Low E

Triple Glazed Leadlight
(Glass for XR5 Shown)



Bevel Flower

Classique

- For more glass designs refer to Glazing Options table on page 62

Specifications

	Solid HMR MDF Core (DB)		
	Unglazed	Rw:30	STC:29
	Glazed	Rw:31	STC:31
	BAL12.5		
	40kg (820mm)		58kg (1200mm)



ENTRANCE DOORS
NEXUS

S I

Subtle & Stylish

Created with a clever urban design, the Nexus range allows for an exquisite parallel between the cityscape and your home. Choose from an array of glass options to create your own stylish and urban look.



NEX100



NEX30



NEX35



NEX36



NEX38



NEX40

Face Options



DuraXP (standard)



SPM



Merbau



Tassie Oak



Blackbutt

Glass Options



Clear



Cathedral



Grey Tint



Translucent



Africana

■ For more glass designs refer to Glazing Options table on page 62

Specifications

	Solid HMR MDF Core (DB)	
	Rw:31	STC:31
	BAL12.5	
	40kg (820mm)	58kg (1200mm)

- Standard Door Size: 2040x820x40 (NEX40 excluded), 2040x1200x40 (NEX40 only)
- Custom Door Size: Min 1990x805x40 - Max 2400x1200x40 (NEX40 excluded) Min 1990x1020x40 - Max 2400x1200x40 (NEX40 only)
- NEX30 always has 3 glass panels including made to order
- NEX40 always has 4 glass panels including made to order



ENTRANCE DOORS

VAUCLUSE PREMIER



Premium & Superior by Design



Image supplied by Maine House Interiors

Vaucluse Premier doors are an elegant addition to any facade, with simple yet stunning carved patterns on both door faces and attractive mouldings on the exterior face that complement both classic and modern home styles. Choose from the variety of glass options to match these designs to your décor.



ENTRANCE DOORS

VAUCLUSE PREMIER



XVP11



XVP12



XVP13



XVP20



XVP22



XVP22 (1200)

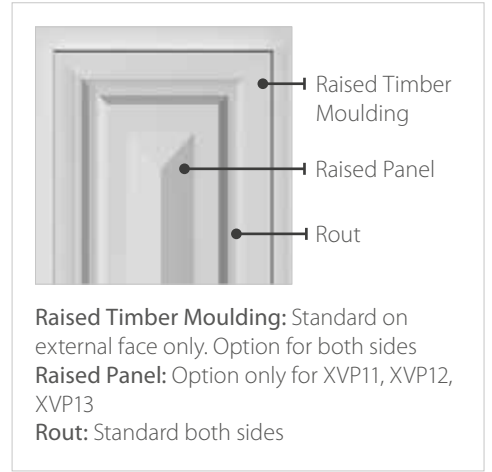

- Standard Door Size:
2040x820x40, 2040x1200x40
- Custom Size Doors:
Min 1990x805x40 - Max 2400x1200x40
- Standard Sidelite Size:
2040x400x40
- Sidelite Size:
Min 1990x330x40 - Max 2400x500x40

Face Options

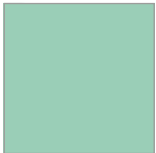

DuraXP (standard)



SPM

Glass Options



Clear



Cathedral



Grey Tint



Translucent



Africana



Low E



Rice Paper

■ For more glass designs refer to Glazing Options table on page 62

Specifications

	Solid HMR MDF Core (DB)		
	Unglazed	Rw:30	STC:29
	Glazed	Rw:31	STC:31
	BAL12.5		
	40kg (820mm)		58kg (1200mm)



ENTRANCE DOORS

CARRINGBUSH



Classic & Timeless

The Carringbush range recreates the timeless beauty of the Victorian era. Featuring detailed timber mouldings, strong cricket bat panels and a ledge and scroll on the exterior door face and routed designs each side.

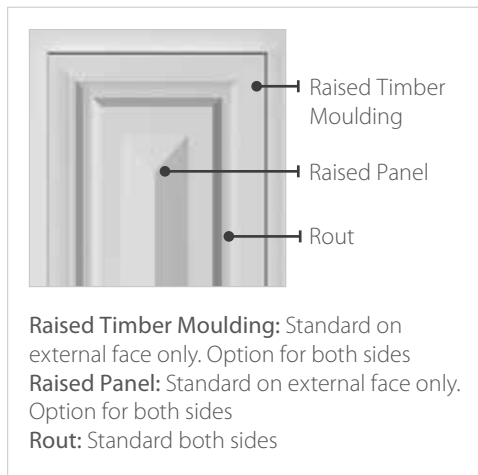

- Standard Door Size: 2040x820x40
- Custom Door Size: Min 1990x805x40 - Max 2400x1100x40
- Standard Sidelite Size: 2040x400x40
- Custom Sidelite Size: Min 1990x330x40 - Max 2400x520x40
- Doors above 2100mm high will have design limitations. Refer to your local branch for more information
- Scroll & Ledge: Standard on external face only under glass

Face Options

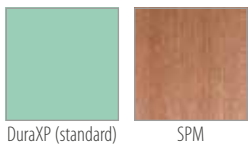

Glass Options



Triple Glazed Leadlight Glass



Specifications

	Solid HMR MDF Core (DB)	
	Rw:31	STC:31
	BAL12.5	
	40kg	



ENTRANCE DOORS

GLASS OPENING

S H I

Minimalistic & Functional

The perfect balance between functionality and style with the option of honeycomb or solid core construction. These classic back door designs are crafted from tempered hardboard or select timbers, with a range of glass options available to suit your style.



XF1



XF3



XF8

Specifications (XF1, XF3)

	Honeycomb (X1)	
	Rw:25	STC:25
	Nil	
	18kg	

Specifications (XF8)

	Solid HMR MDF Core (DB)/ Solicore (SCX1)	
	Rw:31	STC:31
	BAL12.5	
	40kg	

Face Options



DuraXP (standard)

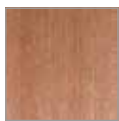

SPM



Paint Grade Ply
XF1, 3



Merbau
XF1, 3



Tassie Oak
XF1, 3

Glass Options



Clear



Cathedral



Grey Tint

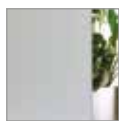

Translucent



Africana



Geostep



Low E



Rice Paper

- Standard Door Size: 2040x820x35/40
- Custom Door Size: Min 1990x705x35/40 - Max 2400x1200x35/40
- Rout (XF8 only): Standard one side. Option for both sides



ALFRESCO MULTIFOLD



■ **Perimeter Seals**
Full perimeter seal which improves energy efficiency and reduces noise



■ **Sealed Gaskets**
High-quality gaskets at frame joints for superior sealing



■ **Adjustable Door Height**
Easy door adjustments without having to remove the door panels



■ **Secure & lockable**
Keyed drop bolts fitted as standard

- The warmth and natural beauty of timber doors
- Moisture draining system for excellent weather performance
- Durable roller system for smooth panel operation
- Preassembled for ease of installation
- Low E glazing option for increased energy efficiency

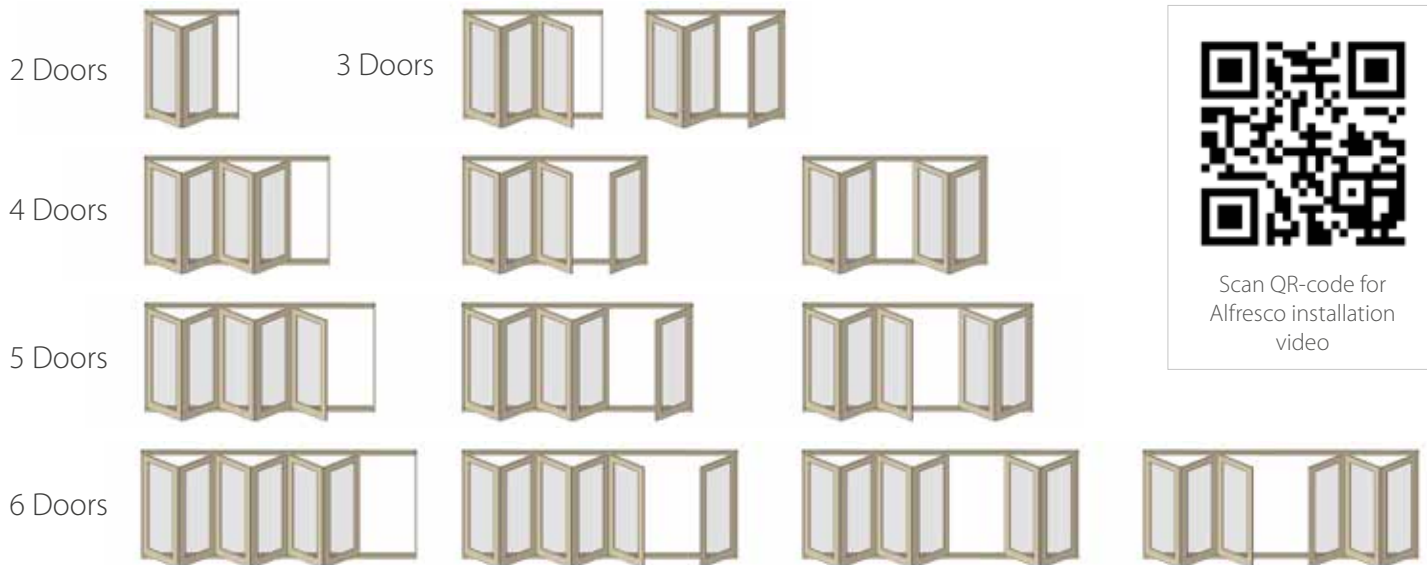

- All options shown above are also available in reverse
- All diagrams are viewed from the outside and all Alfresco doors open to the outside

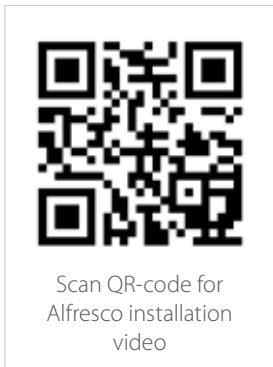



ENTRANCE SYSTEMS PIVOT FRAMES

Make your grand entrance exceptional with the Hume Pivot System. An entry frame which features a heavy-duty pivot design with quality fittings that allow the door to be adjusted during installation. With the inclusion of perimeter seals, this system gives you everything you need to create a bold statement and increase your home's street appeal.



Concealed Hydraulic Self Closer

Adjustable closing speed control and soft-close allow for safe closing speeds and no slamming of your door. Hold open function at 90 degrees to create a generous entrance

Perfect for Large Doors

Heavy-duty pivot fittings to suit any oversized door from our extensive range of large doors

Full Perimeter Seal

Pivot systems have a full perimeter seal which improves energy efficiency and reduces noise

Bottom Sill

Solid timber sill looks sleek & elegant due to a top-mounted pivot mechanism



Door Adjustment Hole

Easily adjust your pivot without removing the door, so it is plumb and square

Head

Made of premium timber and designed to incorporate the pivot operating system

Optional glazed sidelite/s or hilite

Factory Assembled Frame

Fully assembled and packaged ready for your home. Simply install and enjoy

Stop Bead

Fitted with perimeter seal, improves energy efficiency

Bottom Seal

A sleek aluminium bottom seal, designed with energy efficiency in mind



Scan QR code to view Pivot installation video

Handing of Frame & Configuration Codes

*Victoria Configuration Codes

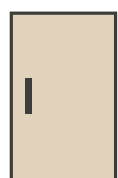

A
*PIV1RH
outside

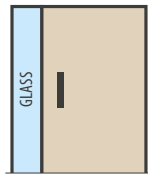

CG
*PIV2RH
outside

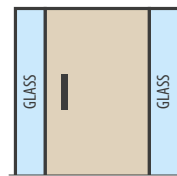

EG
*PIV3RH
outside

B
*PIV1LH
outside

DG
*PIV2LH
outside

FG
*PIV3LH
outside

Pivot Frame Sill Protector

Protects the door sill from damage during construction and keeps door sill looking new.



Specifications



BAL12.5
(Meranti frames only)

DOORS NOT INCLUDED

- Allow for up to 1200 wide door
- Choose from any oversize door in our entrance range
- Door cost is additional
- Order door and frame together to ensure perfect fit



■ Factory Assembled Frame

Fully assembled, factory fitted hinges and packaged ready for your home. Our frames have been designed to suit most openings

■ Timber Jambs & Head

Made of premium timber and designed to suit Australian conditions. Choose from Primed H3 Treated Pine, Meranti or Merbau to best suit your needs

■ Factory Fitted Hinges

Frame supplied with hinges

■ Durable Hardwood Bottom Sill

Made from solid timber and slanted in design. The hardwood sill is a sleek and elegant threshold that improves moisture control

■ Multiblade Rubber Seal

Provides maximum weather protection

Handing of Frame & Configuration Codes

*Victoria Configuration Codes

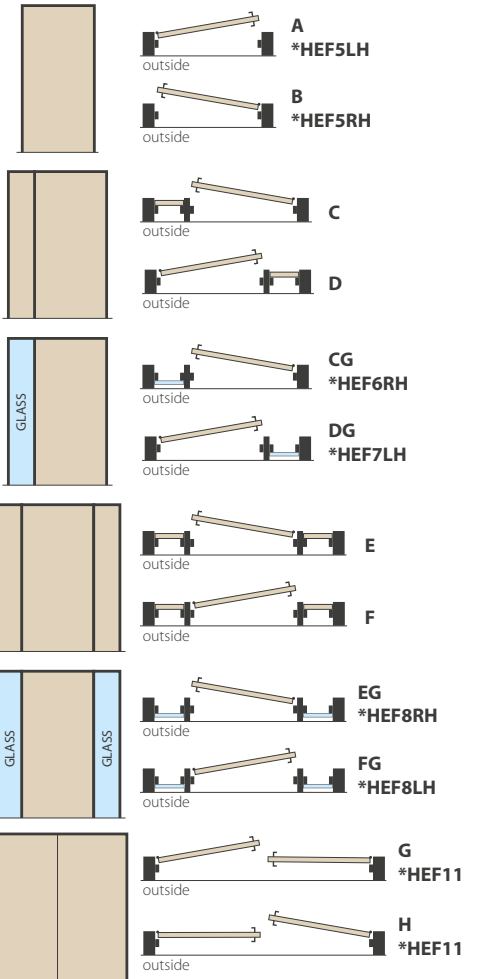

■ Durable Anodised Aluminium Plate

A strong and sleek bottom seal. Designed with energy efficiency and weather protection in mind

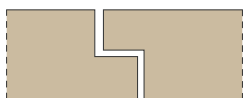

REBATED
For pairs of doors to eliminate draughts, noise, etc. Reduces the width of a pair of doors by 12mm.

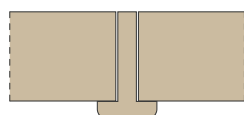

MUSHROOM STOP
Mushroom stop is an alternative to rebated doors for pairs of doors to eliminate draughts, noise etc. Increases the width of a pair of doors by 12mm.

DOORS NOT INCLUDED

- Choose from any door in our entrance range
- Door cost is additional
- Order door and frame together to ensure perfect fit. When ordered together door is supplied with machine cut outs for hinges
- Hinges are additional cost in Victoria
- Multiblade Rubber Seal is an additional cost in Victoria



■ **Factory Assembled Frame**
Fully assembled, factory fitted hinges and packaged ready for your home. Our frames have been designed to suit most openings

■ **Timber Jamb & Head**

Made of premium timber and designed to suit Australian conditions. Choose from Primed H3 Treated Pine, Meranti or Merbau to best suit your needs

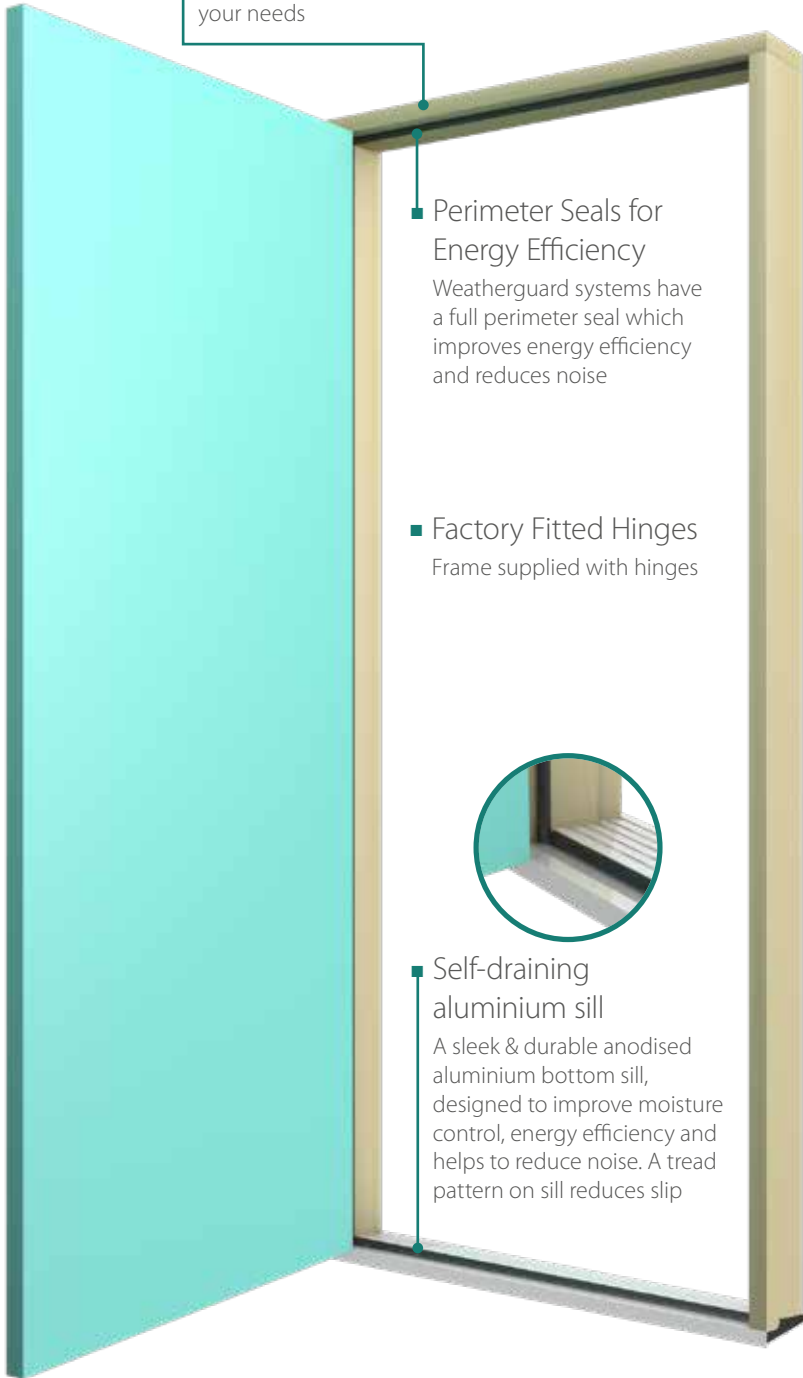

■ **Perimeter Seals for Energy Efficiency**

Weatherguard systems have a full perimeter seal which improves energy efficiency and reduces noise

■ **Factory Fitted Hinges**

Frame supplied with hinges



■ **Self-draining aluminium sill**

A sleek & durable anodised aluminium bottom sill, designed to improve moisture control, energy efficiency and helps to reduce noise. A tread pattern on sill reduces slip

Handing of Frame & Configuration Codes

*Victoria Configuration Codes

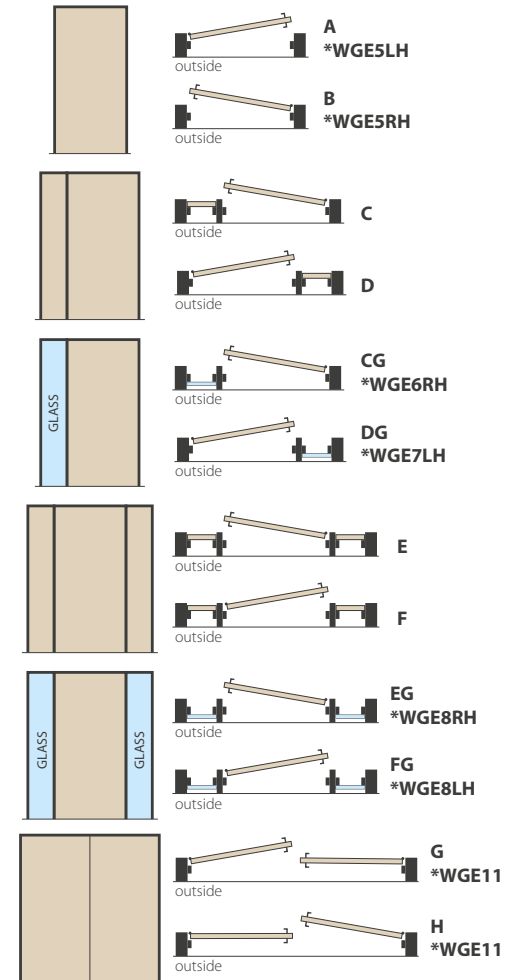

■ **Weatherguard Frame Sill Protector**

Protects the door sill from damage during construction and keeps door sill looking new.

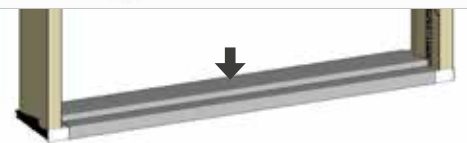

Specifications

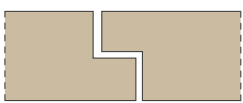

REBATED
For pairs of doors to eliminate draughts, noise, etc. Reduces the width of a pair of doors by 12mm.

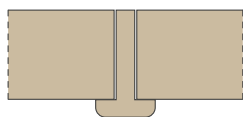

MUSHROOM STOP
Mushroom stop is an alternative to rebated doors for pairs of doors to eliminate draughts, noise etc. Increases the width of a pair of doors by 12mm.

	Rw:31	STC:31
	BAL12.5 (Meranti frames only)	

DOORS NOT INCLUDED

- Choose from any door in our entrance range
- Door cost is additional
- Order door and frame together to ensure perfect fit. When ordered together door is supplied with machine cut outs for hinges
- Hinges are additional cost in Victoria



Hume Doors & Timber has extensively tested our comprehensive range of doors and door frame systems to meet the AS1530.8.1 criteria set for buildings in Bushfire Attack Level (BAL) zoned areas. All our BAL tests are conducted in Australia by an independent third-party fire testing consultancy firm.

Doors must be installed as per AS3959 to conform to BAL compliance. Refer to our website for further information: www.humedoors.com.au

Bushfire Attack Level (BAL) measured in increments of radiant heat expressed in kilowatts /m². This defines your BAL Rating requirement. The diagram below shows the BAL ratings along with the radiant heat flux for each zone.

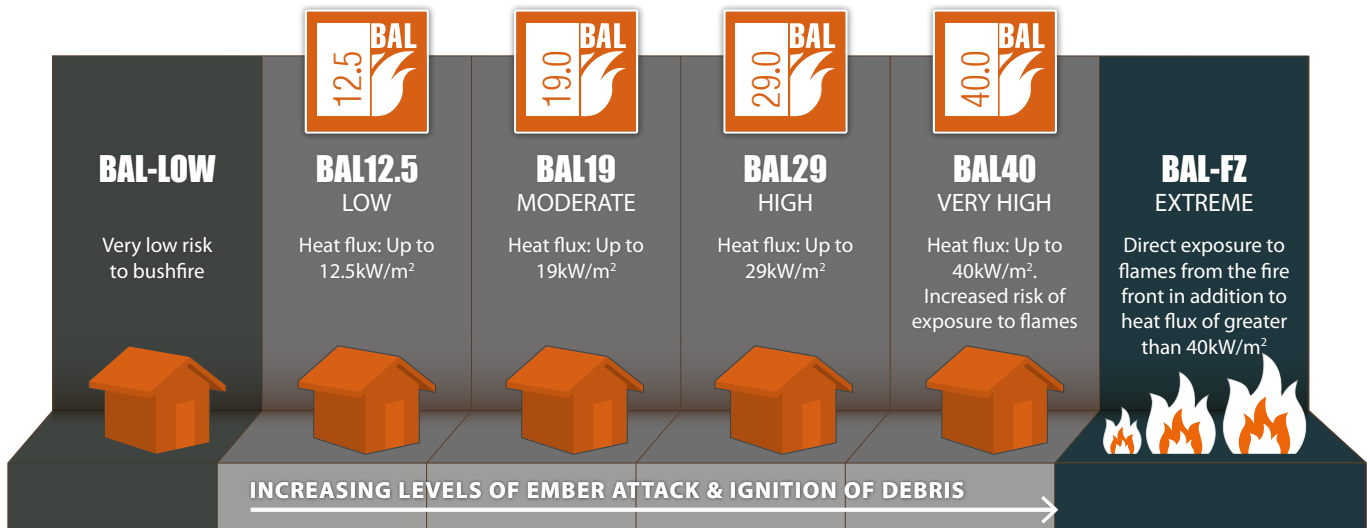

■ Check specifications tables for each range to see BAL ratings for doors and frames



BAL12.5 DOORS & FRAMES

The complete range of Entrance Doors are BAL12.5 compliant (Pages 8-31)

- NOTE: ILLUSION RANGE (Page 18)
BAL12.5 is only available for doors glazed with Clear Laminate, Grey Laminate and Translucent
- NOTE: GLASS OPENING RANGE (Page 27)
BAL12.5 is only available for 40mm thick and solid construction
- PIVOT FRAMES (Page 29)
Meranti Pivot System Only

WEATHERGUARD ENTRY FRAMES (Page 31)

- Meranti Weatherguard Frames Only
- Tested to AS1530.8.1 when supplied as a complete unit (door & frame)
- BAL12.5 compliant when installed as per AS3959.
- Tested to AS1530.8.1 when supplied as a complete unit (door & frame)
- BAL12.5 compliant when installed as per AS3959



BUSHFIRE RESISTANT DOORS & FRAMES BAL19 & 29 DOORS



BFR1



BFR2



BFR3



BFR4



BFR5



BFR8



BFR9



BFR12



BFR13



BFR14



BFR15

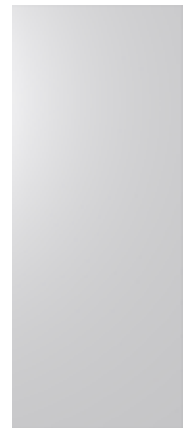

BFR30

Face Options

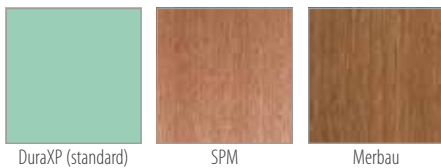

DuraXP (standard)

SPM

Merbau

6mm Toughened Glass Options



Clear (6mm)

Grey Tint (6mm)

Africana (6mm)

Frost (6mm)

Specifications

	Solid HMR MDF Core (DB)		
	Unglazed	Rw:30	STC:29
	Glazed	Rw:31	STC:31
	BAL19 & 29		
	40kg		

BAL19 & 29 Glazing Profile

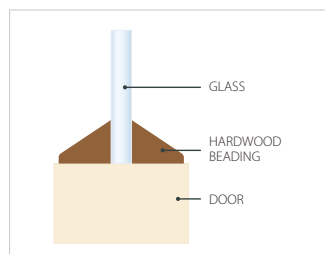

- Standard Door Size: 2040x820x40
- Custom Door Size: Min 1990x805x40 - Max 2400x1200x40
- Door thickness is 40mm and meets the requirements for BAL12.5, BAL19 & BAL29 zones
- Order door and frame together to ensure compliance with BAL
- Hinges: Doors up to 2040x820x40 must have three 100mm square butt hinges. Doors over this size must have four 100mm square butt hinges
- Rout (BFR9 only): Standard both sides
- Raised Timber Moulding (BFR12 & BFR13 only): Standard on external face only
- BFR12 & BFR13 not available in Merbau



BAL40 DOORS



Face Options



6mm Toughened Glass Options



BAL40 Glazing Profile

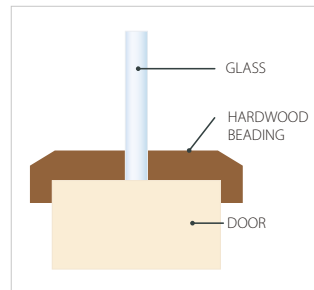

Specifications

	BAL40 Construction	
	Rw:31	STC:30
	BAL40	
	45kg	

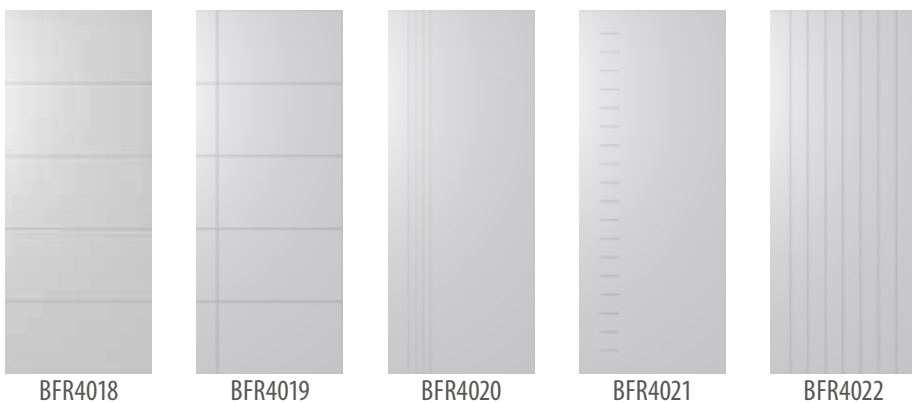

Face Options

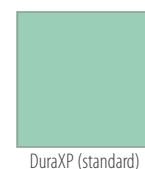

Specifications

	BAL40 Construction	
	Rw:31	STC:30
	BAL40	
	45kg	



BELOW POINTS ARE FOR ALL BAL40 DOORS

- Standard Door Size: 2040x820x45
- Custom Door Size: Min 1990x805x45 - Max 2340x1200x45
- Standard Sidelite Size: 2040x400x45
- Custom Sidelite Size: Min 1990x330x45 - Max 2340x500x45
- Door thickness is 45mm and meets the requirements for BAL40 zones
- SPM & Merbau not available for BFR4017
- Door & Frame must be supplied together to comply to BAL40 as tested to AS1530.8.1
- Door systems supplied with a minimum four 100mm square butt hinges as tested to AS1530.8.1 and compliant to BAL40
- 6mm Toughened safety glass and double sided fire-resistant hardwood glazing bead as tested to AS1530.8.1



■ Factory Assembled Frame

Fully assembled with an intumescent fire & smoke perimeter seal compliant to BAL19 & 29, the seal is removable for painting and is easily reinstalled. Frame has factory fitted hinges

■ Timber Jambs & Head

Made of premium hardwood. BAL19 & 29 Weatherguard entrance frames are suited for bushfire zones BAL12.5, 19 & 29 when installed as per AS3959

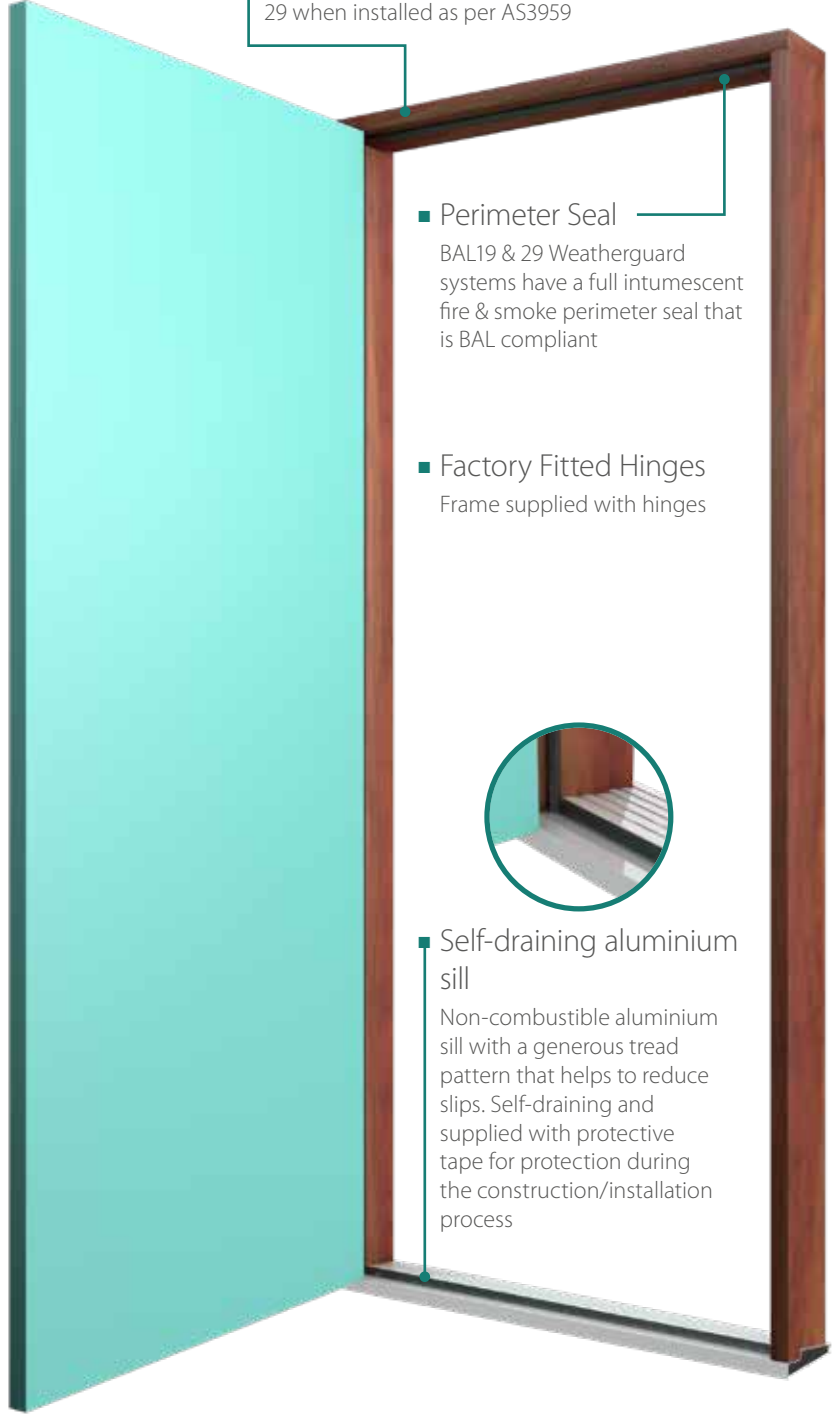

■ Perimeter Seal

BAL19 & 29 Weatherguard systems have a full intumescent fire & smoke perimeter seal that is BAL compliant

■ Factory Fitted Hinges

Frame supplied with hinges

■ Self-draining aluminium sill

Non-combustible aluminium sill with a generous tread pattern that helps to reduce slips. Self-draining and supplied with protective tape for protection during the construction/installation process

Handing of Frame & Configuration Codes

*Victoria Configuration Codes

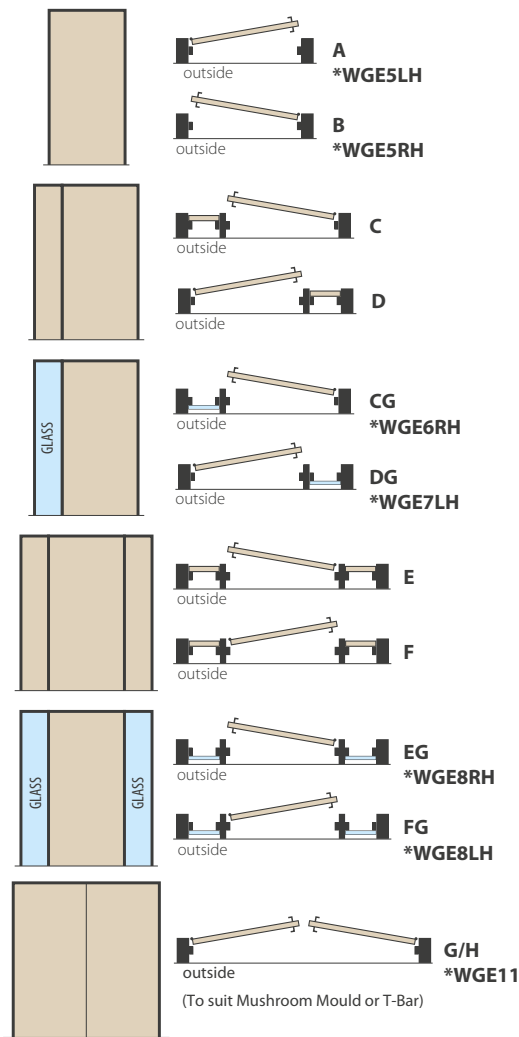

- BAL19 & 29 Merbau Weatherguard entrance frames are suited for bushfire zones BAL12.5, BAL19 & BAL29 when installed as per AS3959
- CG/DG & EG/FG frames are glazed using 6mm toughened glass and must be screened with a BAL compliant screen as per AS3959 (screen not included)

Specifications

	Rw:31	STC:31
	BAL19 & 29	

DOORS NOT INCLUDED

- Choose from any door within the BAL19 & BAL29 door range. Door cost is additional
- Order door and frame together to ensure compliance with BAL and perfect fit
- Door is supplied with machine cut outs for hinges when ordered with frame
- Hinges supplied with frame



■ Factory Assembled Frame

Tested to AS1530.8.1 and compliant to BAL40. Our fully assembled BAL40 frames are factory fitted with 4 hinges. Frames are fitted with an intumescent fire & smoke perimeter seal

Handing of Frame & Configuration Codes

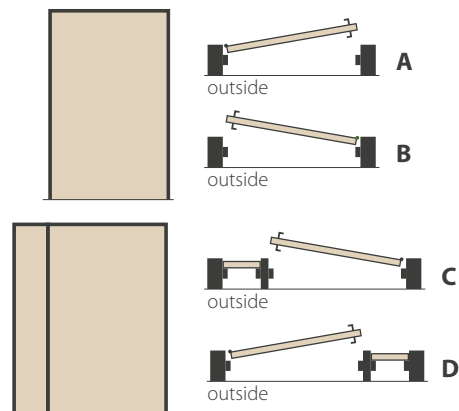

Watch our BAL40 burn test video.

■ Timber Jambs & Head

Made of premium hardwood. BAL40 Weatherguard entrance frames are tested to AS1530.8.1 and compliant to BAL40

■ Perimeter Seal

BAL40 Weatherguard systems have a full intumescent fire & smoke perimeter seal that is BAL compliant and tested to BAL40

■ Factory fitted with 4 Hinges

Frame supplied with hinges



■ Self-draining aluminium sill

Non-combustible aluminium sill with a generous tread pattern that helps to reduce slips. Self-draining and supplied with protective tape for protection during the construction/installation process

- Door & Frame must be supplied together to ensure compliance with BAL40
- Choose from any door within the BAL40 door range
- Door is supplied with machine cut outs for hinges
- BAL40 Merbau Weatherguard entrance frames have been tested to comply with BAL40 and are manufactured as per AS1530.8.1

Specifications

	Rw:31	STC:31
	BAL40	



INTERNAL BARN DOORS

FRONTIER TRACK SYSTEM



- Powder Coated Track
Architecturally designed premium track system with a powder coated finish
- Smooth & Quiet
Nylon wheels allow for smooth and quiet rolling along a flat bar track
- Classic Barn Door Look
Exposed steel straps
- Easy to Install
Perfect for DIY



Scan QR code to see
Frontier Barn Door Sliding
System installation video



INTERNAL BARN DOORS

FRONTIER STANDARD BARN DOORS



FBDS1



FBDS2



FBDS3



FBDS4



FBDS5



Frontier Standard Profile

Specifications

	Frontier Premium Hollow Core (SG)
	30kg

- Standard Door Size: 2150x1000x35
- Deep linear rout designs
- Available in PCMDF for paint or SPM for Stain
- Made to measure customised designs and sizing available



INTERNAL BARN DOORS

FRONTIER **ULTIMATE** BARN DOORS



FBDU1



FBDU2



FBDU3



FBDU4



FBDU5





FBDU7



Frontier Ultimate Profile

Specifications

	Frontier Ultimate Solid Infill Core
	48kg

- Standard Door Size: 2150x1000x35
- Frame and Infill constructed shaker style door
- Available in PCMDf or paint



INTERNAL DOORS
HAMPTON



Coastal, Raw & Elegant



Bring the holiday feeling to your home with the Hampton collection. These elegant designs focus on raw, natural details that evoke a coastal feel. Choose from our glass options and create your escape with this stylish range.



INTERNAL DOORS HAMPTON



HAM1



HAM2

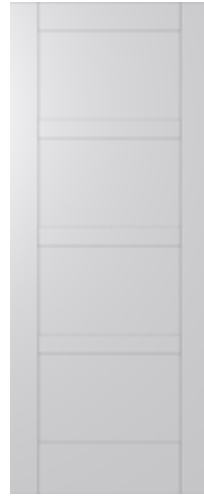

HAM4



HAM5



HAM10



HAM6

Specifications

	Hampton Construction (Internal)
	20kg

- Standard Door Size:
2040x520/620/720/770/820x35
2340x520/620/720/770/820x35
- Custom Door Size:
Min 1990x400x35 - Max 2400x1200x35

Face Options



Primed MDF (standard)

Glass Options



Clear



Translucent



HAM1 (TRANSLUCENT)



HAM4 (CLEAR)

All Hampton door designs are available with Translucent and Clear glass options



INTERNAL DOORS

HUMECRAFT



Discreet & Tasteful



Where quality meets versatility, the Humecraft range features broad square carved designs on both sides. These solid construction doors create a simple yet tasteful design that is perfect for a subtle look that can be carried right through the home with the availability of bi-folds.



INTERNAL DOORS
HUMECRAFT

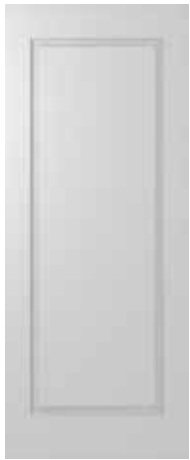

HMC1



HMC2



HMC4



HMC7



HMC8



HMC10



HMC11

Specifications

	Solid HMR MDF Core (HV Internal)	
	Rw:29	STC:29
	30kg	

- Standard Door Size:
 2040x520/620/720/770/820x35
 2340x520/620/720/770/820x35
- Custom Door Size:
 Min 1990x410x35 - Max 2400x1200x35
- Rout: Standard both sides (HMC11 excluded)
- For Bi-fold option refer to page 56

Face Options

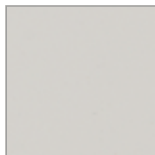

Primed MDF
(standard)



DuraXP



SPM

Glass Options



Clear



Cathedral



Grey Tint

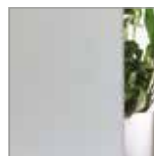

Translucent



Africana



Rice Paper



INTERNAL DOORS

SORRENTO

M H

Modern & Luxurious

Elevate your home's design with the luxurious and contemporary Sorrento range. The beautifully carved door designs feature on both sides and are produced on a deluxe primed door face.



SOR1



SOR2



SOR5



SOR6



SOR7



SOR8



SOR11



SOR12

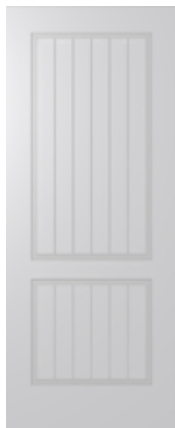

SOR22

Face Options



Primed MDF
(6mm thick)

Specifications

	Honeycomb Core (Hollow Core SG) - 6mm Skin	
	Rw:27	STC:27
	18kg	

- Standard Door Size:
2040x520/620/720/770/820x35
2340x520/620/720/770/820x35
- Custom Door Size:
Min 1990x410x35 - Max 2400x1200x35
- Rout: Standard both sides
- For Bi-fold option refer to page 56



INTERNAL DOORS JOINERY

S H C

Class & Charm

The Joinery range is where modern functionality and classical style collide. Crafted from select timbers and available with a wide variety of glass options, this range features an engineered joinery construction system, pairing modern techniques with traditional methods.



Image supplied by 4DRenovations



LIN1



LIN2



LIN10



SAV2

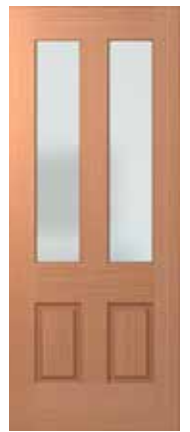

SAV3

Face Options



SPM (standard) Merbau (LIN1) Tassie Oak (LIN1) Blackbutt (LIN1)

Specifications

	Engineered Joinery
	30kg

- Standard Door Size:
2040x620/720/770/820x35 (LIN1, LIN10)
2040x720/770/820x35 (LIN2, SAV2)
2040x820x35 (SAV3)
- Custom Door Size (LIN1 only):
Min 1990x400x35 - Max 2400x1200x35

Glass Options



Clear Clear Laminate Cathedral Double Glaze Clear Grey Tint Translucent Africana Double Glaze Frost Geostep Rice Paper

- LIN1 Clear Glazed comes with safety decals on glass
- For more glass designs refer to Glazing Options table on page 62



INTERNAL DOORS

LINEAR



Striking, Unique & Stylish



Allow the natural beauty of timber to enrich your home or opt for a modern and fresh painted look with the Linear range of doors. Inspired by contemporary European trends, these striking designs will add a unique style to any home.



INTERNAL DOORS

LINEAR



HLR210



HLR230



HLR240



HLR250



HLR270



HLR400



HLR410



HLR500



HLR600

Face Options



Primed MDF
HLR210, 230, 240 270
(standard)



SPM
HLR250, 400, 410, 500, 600
(standard)

Specifications

	Honeycomb Core (Hollow Core SG) - 6mm Skin	
	Rw:27	STC:27
	18kg	

- Standard Door Size:
2040x520/620/720/770/820x35 (HLR210 excluded)
2340x520/620/720/770/820x35 (HLR210 excluded)
2040x620/720/770/820x35 (HLR210 only)
2340x720/770/820x35 (HLR210 only)
- Custom Door Size:
Min 1990x410x35 - Max 2400x1200x35
- Rout: Standard both sides
- Not suitable for rebated pairs
- Alignment of horizontal rout is not guaranteed for pairs

Glass Options



Clear



Cathedral



Grey Tint



Translucent



Africana



INTERNAL DOORS ACCENT

M S H I

Elegant & Fashionable

Simple and stylish, the Accent internal range features on-trend horizontal and vertical designs which are the perfect complement to any architectural theme.



HAG9
PRE9



HAG11
PRE11



HAG12
PRE12



HAG14
PRE14



HAG18
PRE18



HA4
PRE4



HA5
PRE5



HA40
PRE40

Face Options



Primed MDF
(standard)



DuraXP

- Standard Door Size:
2040x410/420/460/520/620/720/770/820x35
2340x520/620/720/770/820x35
- Custom Door Size: Min 1900x400x35 - Max 2400x1200x35
- Additional Extra: Solicore Particleboard Core (SCX1 PCMDF)
- Rout: Standard both sides
- Alignment of horizontal rout is not guaranteed for pairs
- Not suitable for rebated pairs
- For Bi-fold options refer to page 56

Specifications (HAG, HA)

	Honeycomb Core (Hollow Core H1)	
	Rw:25	STC:25
	14kg	

Specifications (PRE)

	Honeycomb Core (Hollow Core SG) 6mm Skin	
	Rw:27	STC:27
	18kg	

	Solcore Particleboard Core (SCX1 PCMDF)	
	Rw:29	STC:29
	30kg	



INTERNAL DOORS
STRATA

M I

Classy, Modern & Innovative

Bring a unique and modern statement into your home with the Strata range, featuring an eloquent vertical and horizontal textured pattern that perfectly balances class and creativity. Primed and ready for painting, add a splash of innovation by adding a metallic strip.



HST1



HST4



HST5



*HST1M



*HST4M

All Strata Design doors are available in 2340mm high option



HST1 (2340mm)

Face Options



HST1



HST4



HST5



*HST1M



*HST4M



Details of Strata textured surface

Specifications

	Honeycomb Core (Hollow Core H1)	
	Rw:25	STC:25
	15kg	

- Standard Door Size:
2040x520/620/720/770/820x35
2340x520/620/720/770/820x35
- Custom Door Size:
Min 1990x330x35 - Max 2340x920x35
- *HST1M and HST4M includes a metal strip
- For Bi-fold option refer to page 56



INTERNAL DOORS

MOULDED PANEL

WOODGRAIN SKIN **H** **C**

Classical & Timeless

It's all in the details with the Moulded Panel range. These beautiful woodgrain embossed pre-primed doors come in a variety of styles to complement any classical architecture.



Oakfield



OAK-G

Caprice



OAK



CAP

Pacific



PAC

Denmark



DEN

Face Options



Moulded Panel
Woodgrain Skin

Glass Options



Clear

Cathedral

Grey Tint

Translucent

■ For more glass designs refer to Glazing Options table on page 62

Specifications

	Honeycomb Core (Hollow Core H1)	
	Rw:25	STC:25
	15kg	

	Solicores Particle Board Core (Infill Panel)	
	Rw:30	STC:29
	30kg	

- Standard Door Size:
2040x410/420/460/520/620/720/770/820x35 (OAK, CAP, PAC, DEN)
2040x720/770/820x35 (OAK-G)
- Additional Extra: Solicores Particle Board (Infill Panel)
- For Bi-fold options refer to page 56



INTERNAL DOORS

MOULDED PANEL

SMOOTH SKIN



Traditional & Refreshing

Embracing a refreshingly elegant design, these doors feature embossed smooth faces and come in a variety of styles. With the benefit of 2340 high doors with our Ascot model, the Moulded Panel range has it all.



Ascot



Hayman



Face Options



Moulded Panel
Smooth Skin

Glass Options



■ For more glass designs refer to Glazing Options table on page 62

Specifications

	Honeycomb Core (Hollow Core H1)	
	Rw:25	STC:25
	15kg	

	Solicores Particle Board Core (Infill Panel)	
	Rw:30	STC:29
	30kg	

- Standard Door Size:
2040x410/420/460/520/620/720/770/820x35 (ASC-G excluded)
2040x720/770/820x35 (ASC-G)
2340x620/720/770/820x35 (ASC)
- Additional Extra: Solicores Particle Board (Infill Panel)
- For Bi-fold options refer to page 56



INTERNAL SYSTEMS CAVITY UNITS

■ Recommended for 35mm doors only

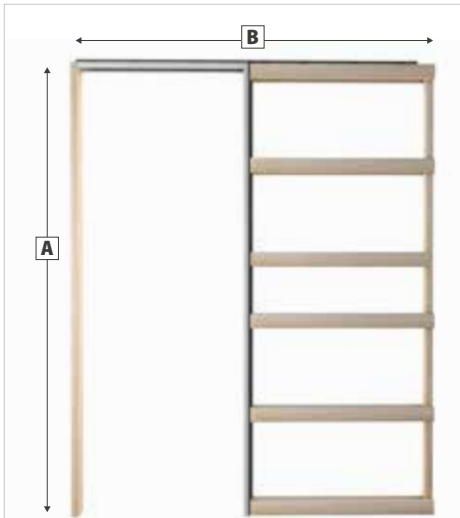

EVOLUTION TIMBER CAVITY UNIT OPENING SIZES

A = Door height + 70mm (QLD, WA)

A = Door height + 80mm (NSW, VIC, ACT, SA, TAS)

Flush Pull opening width:



• **B** = 2 x Door + 10mm

• Flush pull the door protrudes 50mm)

Flush Jamb opening width:



• **B** = 2 x Door + 60mm

• (Flush jamb the door is flush with split jamb)



Scan QR-code for
Cavity installation
video

- NOTE: Unit size is tight, allow extra space for packing when preparing the opening.
- Flush pull not available in QLD
- Closing jamb not included in NSW & QLD



FEATURES	EVOLUTION TIMBER	EVOLUTION TIMBER COMPLETE	EVOLUTION STEEL CAVITY (ASPIRE)	EVOLUTION STEEL COMPLETE (ASPIRE)
Smooth 4 Wheel Ball Bearing Carriages	✓	✓	✓	✓
Jump free U track - Smooth operation	✓	✓	✓	✓
Quick release mechanism	✓	✓	✓	✓
Maximum door mass 70kg	✓	✓	✓	✓
Same architrave height as a hinged door	✓	✓		✓
*Available in plain or H3 treated timber	✓	✓		
One Touch Release System		✓		✓
Soft Closer Technology		✓		✓
Tough Composite Split Jamb			✓	✓
Galvanised steel back posts slats & track - Termite resistant			✓	✓

■ *H3 Treated pine P.O.A.



INTERNAL SYSTEMS

CAVITY UNITS ADDITIONAL EXTRAS

■ ADD ON OPTIONS FOR EVOLUTION TIMBER & EVOLUTION STEEL

SOFT CLOSER

(Smooth operation)

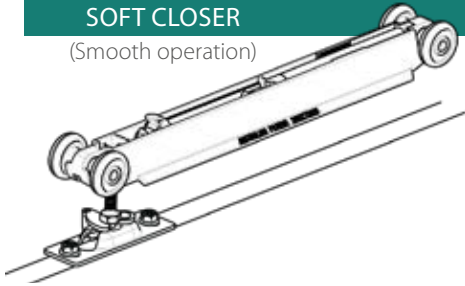

Scan QR-code for Soft Closer installation video

CAVITY TRACK DOOR STOP

(For double cavity application)

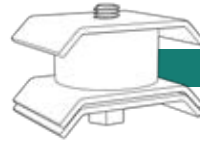

EVOLUTION TOUCH

(One touch release)

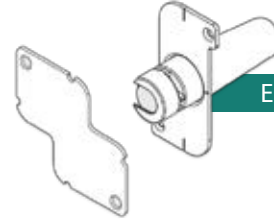

DOUBLE ADAPTOR KIT

(For double cavity application)

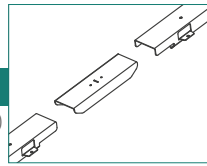
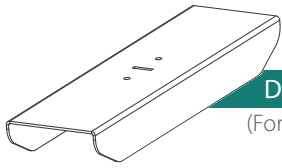

DOOR STIFFENER

Door stiffeners protect Cavity doors from warping. Reduces warping by strengthening the door construction.



INTERNAL SYSTEMS

EVOLUTION PREMIUM



Floor to ceiling zero clearance Cavity Unit

- Floor to Ceiling Zero Clearance
- Creates large open living spaces
- Impressive large door openings
- Virtually invisible - hidden track system
- Soft closer - prevents door slamming
- One touch operation - push to release door



Every Evolution Premium unit is a fully customised solution

To download the order form go to www.humedoors.com.au/door-systems and look for Evolution Premium Floor to Ceiling Cavity Unit.

IMPORTANT INFORMATION FOR PREMIUM CAVITY UNIT

Maximum Door Size	3000x1300mm
Maximum Door Weight	120kg
Stud Thickness	90mm
Soft Closer	Included as standard
Overall Unit Height	Floor level (slab/sheet) to underside of ceiling + 50mm
Overall Unit Width	Door Width x 2 + 50mm
Door Height Calculation	Finished floor to underside of ceiling less 15mm for clearances
Clearances	Under Door = 10mm Above Door = 5mm (Standard) (Can be adjusted to minimum 3mm)

- Door & Cavity should be ordered together for system operational purposes
- Cancellations or alterations for made to order doors will only be accepted on the day of ordering

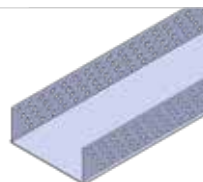

SQUARE SET REVEALS

Cavity Square Set Reveals provide a modern, clean wall finish by replacing timber architraves and timber closing jambs.



INTERNAL SYSTEMS
SMARTROBE



PRIMECOAT



SPM



ACCENT
(PAGE 48)

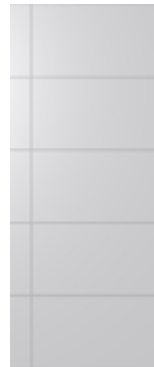

LINEAR
(PAGE 47)



SORRENTO
(PAGE 44)



HAMPTON
(PAGE 41)



HUMECRAFT
(PAGE 43)



STRATA
(PAGE 49)



MIRROR ARCH TOP



FULL MIRROR



MOULDED PANEL
WOODGRAIN
(PAGE 50)



MOULDED PANEL
SMOOTHKIN
(PAGE 51)



■ Space Saving Solution

Smartrobe sliding doors require very little space to open and convert your walls into a practical storage solution.

■ Stylish & Sturdy

We use our sturdy 35mm thick internal doors. This allows us to offer our full Internal Range of doors for sliding doors that fit perfectly into your home design.

■ Mirrored Doors Available

Choosing a mirrored finish makes your room appear larger while giving the room a lighter feel.

■ Smooth & Quiet

Each Smartrobe door includes two nylon wheels encased in steel assemblies



WHEEL ASSEMBLY



TOP TRACK



BOTTOM TRACK

Track Colour Options



White

Chrome

SMARTROBE CALCULATION TABLE

Door height of 2040mm suits Unit height of 2115mm
Door height of 2340mm suits Unit height of 2415mm

Door Width (mm)	Number of doors	No finger Grips		Two Finger Grips per door	
		Unit Size Width (mm)	Stud Size Width (mm)	Unit Size Width (mm)	Stud Size Width (mm)
870	4	3460	3465	3670	3675
	3	2610	2615	2770	2775
	2	1760	1765	1870	1875
820	4	3260	3265	3470	3475
	3	2460	2465	2620	2625
	2	1660	1665	1770	1775
770	4	3060	3065	3270	3275
	3	2310	2315	2470	2475
	2	1560	1565	1670	1675
720	4	2860	2865	3070	3075
	3	2160	2165	2320	2325
	2	1460	1465	1570	1575
620	4	2460	2465	2670	2675
	3	1860	1865	2020	2025
	2	1260	1265	1370	1375
520	4	2060	2065	2270	2275
	3	1560	1565	1720	1725
	2	1060	1065	1170	1175



Scan QR-code for Smartrobe installation video

- Smartrobe doors and Smartrobe Track & Fittings should be ordered together for system operational purposes
- Doors are reversible (except mirror)
- Easy height adjustment. Access located at the bottom edge of the door.



Flush



BF1 PC MDF

BF1 SPM

Accent
(Page 48)



BF HAG9

Sorrento
(Page 44)



BF SOR1

Strata
(Page 49)



BF HST1

- All designs in Accent, Sorrento & Strata ranges can be used for bi-folding solutions. Refer to relevant page
- Refer to page number for matching doors
- All Bi-folds are supplied with track and fittings
- All Bi-folds supplied in reversible 2 door sets, hinged together to suit normal opening widths

Humecraft

(See page 43 for matching door designs)



BF29

BF30

BF35

Moulded Panel Smooth

(See page 51 for matching door designs)



ASCOT
(BF27)

ASCOT-G
(BF28)

HAYMAN
(BF6)



Scan QR-code for
Bi-fold installation
video

Moulded Panel Woodgrain

(See page 50 for matching door designs)



CAPRICE
(BF34)

PACIFIC
(BF15)

OAKFIELD
(BF18)

OAKFIELD-G
(BF19)

DENMARK
(BF26)

- **OPENING SIZES:** Bi-folds are supplied to suit opening sizes of 2040x720/770/820
- **BI-FOLD SIZES:** Bi-folds are supplied in sizes of 2015x712/762/812

Glass Options



Clear

Cathedral

Grey Tint

Translucent

- For more glass designs refer to Glazing Options table on page 62

Bi-fold Configuration

Single Bi-fold



Double Bi-fold



CALCULATE OPENING HEIGHT FOR BI-FOLD (mm)

Leaf Height	2015
Allowance for track and fittings	23
Clearance under leaf for pivot (add extra clearance for floor coverings)	22
Total opening height	2060

CALCULATE OPENING WIDTH FOR BI-FOLD (mm)

Leaf width x number of leaves (eg 405 leaf x 2)	810
Clearance for each gap 3mm x 3	9
Total width	819 for 820 opening



INTERNAL SYSTEMS
MULTI-FOLD

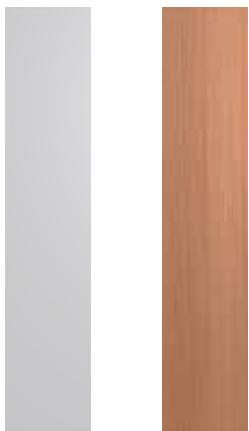

MF1 PC MDF

MF1 SPM

Multi-folds have same design options as Bi-folds. Refer to Bi-folds for more designs

OPENING HEIGHT FOR MULTI-FOLD SETS (mm)		
Leaf Height		2015
Allowance for track & fittings and under door clearance		60
Total height for standard opening		2075
OPENING WIDTH FOR MULTI-FOLD SETS (mm)		
(This example uses a four door application using 405mm leaves)		
Leaf width x number of leaves	(eg 405mm leaf x 4 leaves)	1620
Add 2mm between each leaf	(eg 4 leaves is 3x2mm)	6
Allow 6mm clearance at each jamb	(eg 2x6mm)	12
Total width		1638

- Standard Multi-fold leaf size: 2015x355/380/405x35
- Standard opening height: 2075mm
- Opening width: Refer to table above

Multi-fold Orientation

4 LEAF SET: (2.0m track plus pack/s)



6 LEAF SET : (2.5m track plus pack/s)



8 LEAF SET: (3.4m track plus pack/s)





Scan QR-code for
Prehung installation
video



- **Factory Pre-Assembled Frame**
Factory Assembled System supplied in kit form with hinges already fitted. Made of premium materials and designed to suit Australian conditions.
- **Saves Time & Money**
Quick & easy install. Recommended by Australia's leading builders.
- **Suits All Door Designs**
Choose from any door in our Internal Range
- **Multiple Configurations**
Single, Double, Triple & Four-door units available

HOW TO IDENTIFY HANDING?

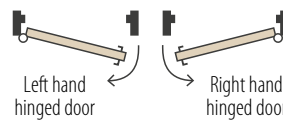

Single Door Jamb Set



- Suits door size (mm):**
- 2040x520/620/720/770/820/870x35
 - 2340x520/620/720/770/820/870x35
 - 2 x stiles
 - 1 x head

Double Door Jamb Set



- Suits door size (mm):**
- 2040x1040/1240/1440/1540/1640x35
 - 2340x1040/1240/1440/1540/1640x35
 - 2 x stiles, 1 x head

Three Door Jamb Set

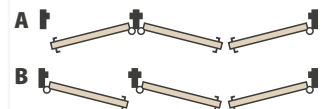

- Suits door size (mm):**
- 2040x1560/1860/2160/2310/2460x35
 - 2340x1560/1860/2160/2310/2460x35
 - 2 x stiles
 - 2 x heads (900/2100mm lengths)
 - 1 x mullion (68/38mm)

Four Door Jamb Set



- Suits door size (mm):**
- 2040x2080/2480/2880/3080/3280x35
 - 2340x2080/2480/2880/3080/3280x35
 - 2 x stiles
 - 2 x head (2 x 2100mm lengths)
 - 1 x mullion 68/38mm

- For all door handing, determine by viewing hinge knuckle on side of door

- Doors and jambs sold separately.
- We recommend ordering door and jamb together to ensure a perfect fit
- Choose from any door in the Internal Range
- Doors supplied hinged only or hinged with pre-drilled face hole to take a handle. Available face hole sizes are 50/32/22mm
- Door is supplied with 2 knuckle half hinge. Jamb supplied with 3 knuckle half hinge plus pin

Prehung Hinge Options



Chrome/Satin Chrome
(standard)



Matt Black



Stainless Steel

- 89mm radius corner loose pin butt hinges
- Choose from chrome, satin chrome, stainless steel or black coloured hinges
- Lift-off hinges are available for water closets at no extra cost. Meets the Australian building code



Lift-off hinge option



FLUSH DOORS

HONEYCOMB CORE

- Timber frame with light weight honeycomb core
- Variety of face materials



	Honeycomb Core (Hollow Core H1)	
	Rw: 25	STC: 25
	14kg (2040x820x40mm)	

	Commercial Primecoat (PCSG) - 6mm Skin	
	Rw: 27	STC: 27
	18kg (2040x820x40mm)	

	Honeycomb Core (Hollow Core X1)	
	Rw: 25	STC: 25
	14kg (2040x820x40mm)	

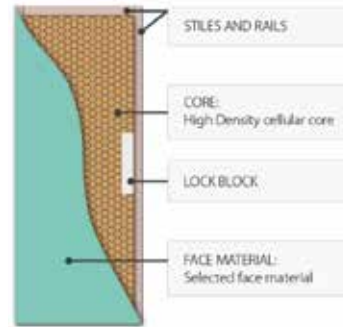
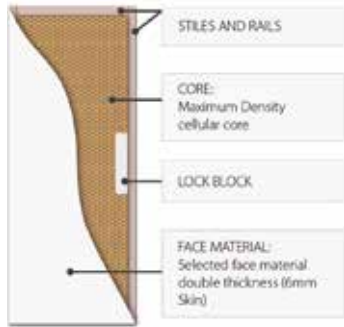
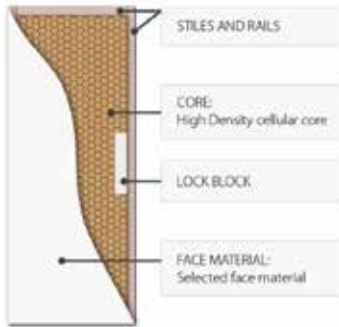

FLUSH DOORS

SOLICORE (SCX1)

	Solicore Particleboard Core (SCX1)		
	35mm	Rw: 29	STC: 29
	40mm	Rw: 30	STC: 29
	45kg (2040x820x40mm)		

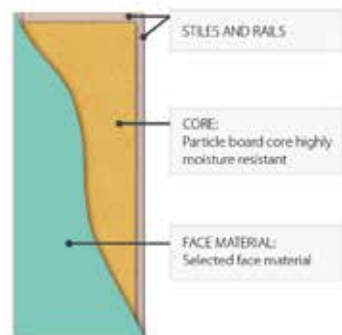

- Timber frame with water resistant particle/flax board core
- Variety of face materials



FLUSH DOORS

BLOCKBOARD (STPC)

	Solid Timber Pine Core (STPC Blockboard)		
	35mm	Rw:29	STC:29
	40mm	Rw:30	STC:29
	35kg (2040x820x40mm)		

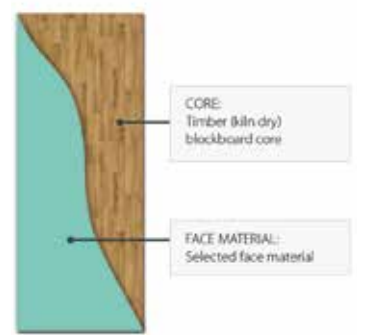

- Pine block core
- Variety of face materials

IMPORTANT NOTE

- STPC doors are not recommended for exposed situations. Consider metal clad doors instead
- Due to open ended core plate all surfaces must be sealed - OTHERWISE GUARANTEE VOID
- Blockboard (STPC) are not recommended for a high quality paint finish due to potential core show-through. For a superior paint finish Solicore (SCX1) doors are recommended



STEEL DOOR FRAME

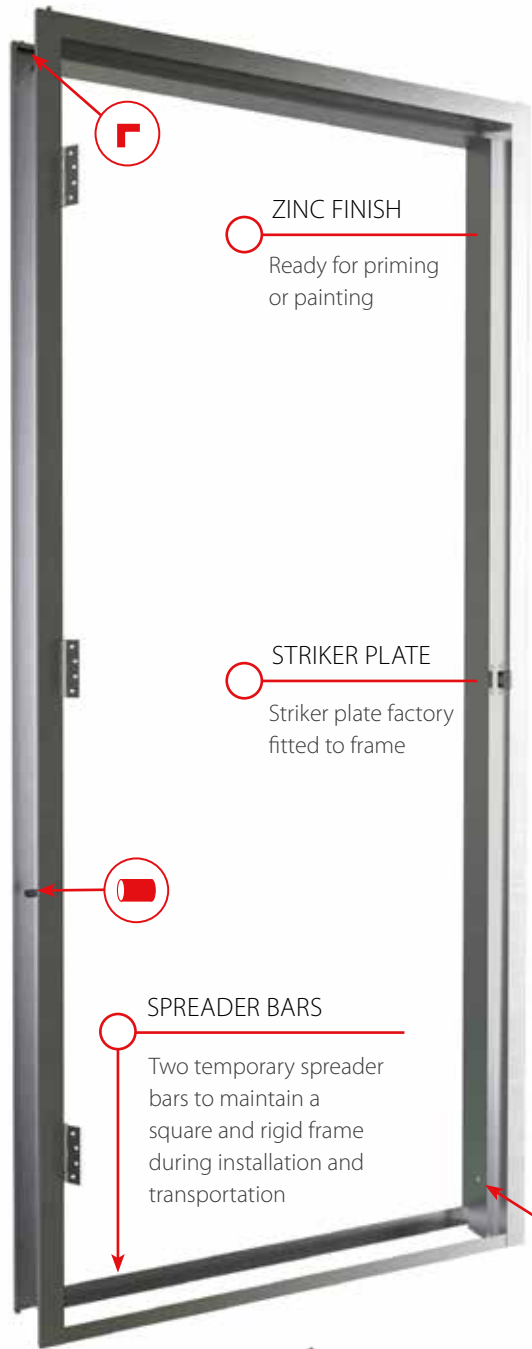

ZINC FINISH

Ready for priming or painting

STRIKER PLATE

Striker plate factory fitted to frame

SPREADER BARS

Two temporary spreader bars to maintain a square and rigid frame during installation and transportation

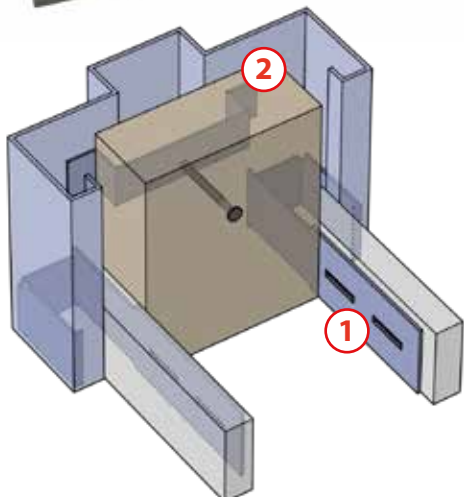

STEEL FRAME PROFILE DETAILS

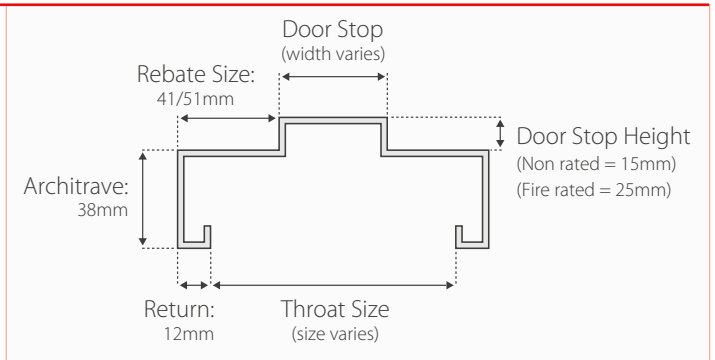

COMPLETE RANGE TO SUIT EVERY APPLICATION

Our team can design and produce any type of steel door frame and will gladly accept your enquiry no matter how unusual.

3 HINGES INCLUDED

Hinges are screw-fixed to the frame for easy door removal. Steel frames require 3 hinges to meet guarantee for solid doors.

CORNER DETAIL

Knock Down frame parts slot together accurately. Push lugs down to secure frame.

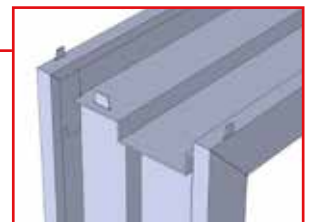

TUBE FIX

Protects the fixing hole from being blocked during the back filling of the frame. Back filling is required for fire rated applications.



DIMPLE FIX

A countersunk hole for a mechanical anchor fixing into masonry walls.

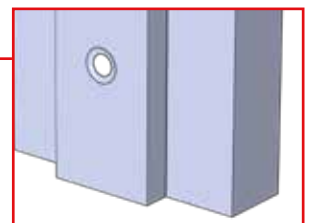

MORE FIXING SOLUTIONS

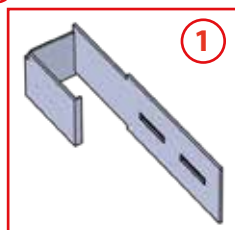

STUD CLIPS

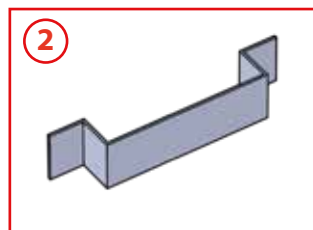

STRAP FIX

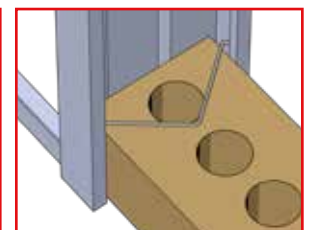

BRICK TIE

■ Steel door frame warranty refer to page 66



HUME COMMERCIAL

ELITE ALUMINIUM DOOR

EMAIL OUR ESTIMATING TEAM FOR PRICING
estimating@humeddoors.com.au

ALUMINIUM ELITE DOOR RANGE

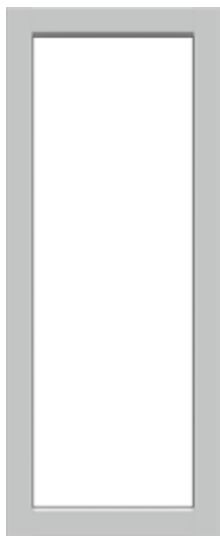

XE1



XE2



XE3



XE4



XE6

- All doors excluding XE2 can be rotated to change the handing. XE2 requires choosing handing when ordering.
- Doors are available with or without door furniture.

ALUMINIUM ELITE DOOR COLOUR/FINISH CHOICES & FITTINGS



White



Grey



Monument



Black



Maple



Merbau



HUME COMMERCIAL

FIRE DOORS

- TVC Firecore available in 1, 2, 3 and 4 hour ratings
- Face Materials: MDF, Ply or Tempered Hardboard
- Vision Panels, Cladding and Air Grilles available
- Match with fire rated Steel Door Frames



FIRE DOOR CONSTRUCTION
Metal Inner Plates for Hinges,
Lock and Closer.



ROBAX
VISION
PANEL



HUME COMMERCIAL
DOORS & FRAMES



Scan QR-code for
Hume Commercial
Catalogue



GLASS

GLAZING OPTIONS

- Square (■) denotes the glass available for this door or sidelite
- Clear glass is available for ALL doors and sidelites
- Availability varies for each state



	DOOR RANGE	Design Code	GLASS OPTIONS						FROST DESIGNS	
			Africana	Rice Paper	Translucent or Frost	Cathedral	Slumped	Geostep	Frost Rose Bud	Panama
ENTRANCE	CARRINGBUSH	XCB1, XCB2			■					
	GLASS OPENING	XF1, XF3, XF8	■	■	■	■		■		
	HAVEN	Full Range (excl. HAV4, 6, 8)			■	■				
		HAV4, HAV6, HAV8			■					
	ILLUSION	XIL1, XIL6	■		■					
		XIL21, XIL26	■		■					
	JOINERY	JST1, JST2, JST11, JST12, JST4, JST5, JST6, JST10	■	■	■	■		■		
	LINEAR (ENTRANCE)	XLR120, XLR160, XLR700	■		■	■				
	NEWINGTON	XN6, XN12	■		■	■	■			
		XN1, XN2, XN9, XN5, XN11, XN14, XN16	■	■	■	■	■	■		
		XN7	■	■	■	■	■	■		
	NEXUS	NEX30, NEX40	■	■	■	■	■	■		
		NEX35, NEX36, NEX38, NEX100	■	■	■	■		■		
	REGENCY	XR5, XR6	■	■	■					
SAVOY 820	XS3, XS4	■	■	■	■			■	■	
	XS11	■	■	■	■	■	■			
	XS24, XS26, XS28, XS45	■	■	■	■		■			
SAVOY1200	XS24, XS26, XS28, XS45	■	■	■	■		■			
VAUCLUSE PREMIER	XVP12, XVP13	■	■	■	■			■	■	
	XVP22	■		■	■					
VERVE	VER1, VER4, VER6, VER11		■	■	■		■			







INTERNAL	HUMECRAFT	BF30	■	■	■	■			■	■
		BF35			■	■				
		HMC11	■	■	■					
	JOINERY/LINCOLN	LIN1, LIN10	■	■	■	■				
		SAV3	■	■	■	■			■	■
	LINEAR (INTERNAL)	HLR210			■					
MOULDED PANEL	OAK-G, BF19, ASC-G, BF28	■	■	■	■				■	

- Glass colours are as accurate as modern photographic and printing processes allow
- Glass images are not to scale
- Factory glazed doors comply with glazing standards AS 1288-2006

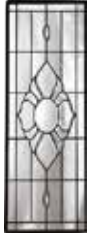

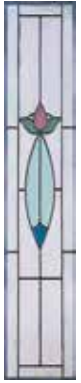
GLASS

GLAZING OPTIONS

		TRIPLE GLAZE LEADLIGHT						BUDGET LEADLIGHT		
										
DOOR RANGE		Triple Glaze Bevelled Jewel	Triple Glaze Bevelled Flower	Triple Glaze Classique	Triple Glaze Tear Drop	Triple Glaze Argyle	Triple Glaze Crystal Blue	Triple Glaze Budget 3 Diamond Bevel	Triple Glaze Budget Bevel Flower	Triple Glaze Budget Diamond Cluster
CARRINGBUSH						■	■			
GLASS OPENING										
HAVEN										
ILLUSION										
JOINERY										
LINEAR (ENTRANCE)										
NEWINGTON										
NEXUS										
REGENCY			■	■	■					
SAVOY 820										
SAVOY1200										
VAUCLUSE PREMIER		■		■	■	■	■	■	■	■
VERVE										
HUMECRAFT										
JOINERY/ LINCOLN										
LINEAR (INTERNAL)										
MOULDED PANEL										



TIMBER

FIBRE-CEMENT PRODUCTS



PRODUCT RANGE		PROFILE	APPLICATIONS	STANDARD WIDTH (mm)	STANDARD LENGTH (mm)
4.5mm PRIMA FLEX		Arrised Edge on all 4 sides 	Suitable for gable end cladding and eaves, carport and verandah linings	450/600	2400
				900	1800, 2400, 2700, 3000
				1200	1800, 2100, 2400, 2700, 3000
6.0mm PRIMA FLEX		Arrised Edge on all 4 sides 	Multi-purpose building boards for external cladding and heavy-duty eaves and ceiling linings.	900	1800, 2400, 2700, 3000
				1200	1800, 2400, 2700, 3000
7.5mm PRIMA PLANK		Square Edge 	Siding board that comes with a choice of smooth and traditional woodgrain finish.	230	4200
				300	4200
7.5mm PRIMA BASE		Square rebate on 2 long sides and 1 edge 	Premium substrate for external texture coating system.	900	2400, 2725, 3000
				1200	2400, 2725, 3000
6.0mm PRIMA AQUA		Square rebate on 2 long sides and sanded 	Water resistant internal linings and eaves lining board for perfect seamless and flush finish.	900	2400, 3000, 3600
				1200	1800, 2400, 2700, 3000, 3600, 4200
				1350	2400, 3000, 3600
6.0mm PRIMA CERAMIC TILE UNDERLAY		Square Edge 	Underlay sheet with preprinted (optional) fixing points.	900	1800
				1200	1800

- For more information visit www.humedoors.com.au/fibre-cement
- Delivery charges apply



TIMBER

TIMBER MOULDINGS PROFILES

■ Delivery charges apply. Contact your Hume Branch for more information.



PINETRIM PLUS® - PRIMED

- Clear of defects
- Great workability
- Pre-primed and ready for painting
- Internal use



PINETRIM XT® H3 L.O.S.P. PRIMED TREATED PINE

- Pest Resistant
- Rot & Fungal Resistant
- Above ground external use



MERANTI

- Natural warmth of solid timber
- Designed for staining
- Traditional and modern designs
- Internal use



SILKTRIM®

- Highly moisture resistant medium density fibreboard (HMR MDF)
- Safe to you and the environment (low formaldehyde levels) (E0)
- Innovative priming system - using the very best formulations to provide the greatest pre finishing coat in the market
- Internal use

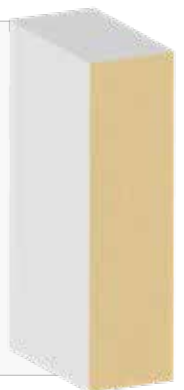

TIMBER MOULDING CATALOGUES
Scan QR code to download

www.humedoors.com.au/downloads#catalogues-timber



TIMBER MOULDING PROFILES
Scan QR code to view

www.humedoors.com.au/timber



GUARANTEE DOORS

Our products come with guarantees that cannot be excluded under the Australian Consumer Law. You are entitled to a replacement or refund for a major failure and for compensation for any other reasonably foreseeable loss or damage. You are also entitled to have the goods repaired or replaced if the goods fail to be of acceptable quality and the failure does not amount to a major failure.

Subject to terms and conditions set forth herein, doors manufactured by: Hume Doors & Timber (Aust) Pty. Ltd., Hume Doors & Timber (Qld) Pty. Ltd., Hume Doors & Timber (Vic) Pty. Ltd., Hume Doors & Timber (SA) Pty. Ltd. or Hume Doors & Timber (WA) Pty. Ltd. (hereinafter referred to as "the Company") are guaranteed by the manufacturer for five years (Fire doors excluded and carry a one year guarantee) from the date of shipment by the manufacturer to be of good material and workmanship, free from defects which render them unserviceable or unfit for the use for which they were manufactured.

TERMS AND CONDITIONS

Natural variations in the colour, texture or grain pattern of the wood or MDF are not to be considered defects. Doors must be accorded reasonable treatment by the purchaser and should be stored or hung in dry buildings and not in damp, moist or freshly plastered areas. The utility or structural strength must not be impaired in the fitting of the door, the application of hardware, or cutting and altering of the door for lights, louvres, panels or any special details. A maximum of 3mm may be trimmed from any edge of the door. This must be done evenly. Normal "show-through" of frame components in doors shall not be considered a defect. Entrance/solid doors up to 2040 x 820 require three hinges, larger doors require four hinges or pivot system. ENTRANCE DOORS & ENTRANCE SYSTEMS SHOULD BE HUNG IN WEATHER PROTECTED AREAS.

Doors and door systems including pivot systems that are installed in a fully exposed situation including opening out doors will not be warranted. Immediately after fitting and prior to hanging, the entire door including the top and bottom edges must be painted. Use a good quality paint or coating system and always follow the

paint manufacturer's advice. Pay particular attention to internal vs external paint systems and use the one appropriate to where you are hanging the door. This includes doors that are supplied raw or factory primed. If staining, must use exterior grade varnish/sealer to prevent absorption of moisture. Always follow the varnish/sealer manufacturer's advice.

SEMI GLOSS OR SATIN FINISHES ARE RECOMMENDED FOR ALL DOORS TO REDUCE "SHOW-THROUGH".

Exterior finishes to be applied strictly in accordance with paint manufacturers instructions. Entrance and exterior doors should be finished in light reflective colours to reduce the risk of heat absorption which causes warping. DARK COLOURS WILL VOID WARRANTY. Regular maintenance should be provided to prevent deterioration. Where any legislation provides for remedies for the Company's breach of a condition or warranty whether statutory or otherwise, then, at the Company's option, the customer's sole remedy for such breach except a breach of Section 69 of the Trade Practices Act will be limited to: such remedy, or the repair of the products, or the replacement of the products or the re-supply of the products; or the payment of the cost of replacing the products; or the cost of having the services supplied again; or the re-provision of the services. No claim will be accepted unless notified in writing to the Company within seven (7) days of the date of delivery of the products or the supply of the services.

The Company will not be held responsible for additional charges of hanging, painting or other charges arising from the replacement of doors. Any such defects must be brought to the attention of the manufacturer when discovered and in any event within five years from the date of shipment by the Company. The Company is not liable to reimburse any purchaser for doors repaired or replaced without the prior written consent of the Company to such repair or replacement. The Company will not assume responsibility for doors which become defective because of failure to follow these conditions or hazards of shipment or storage, after doors leave the control of the Company. The Company will not be liable for any costs, claims, damages or demands arising from the personal injury, loss or damage whatsoever occurring to the customer or its agents, servants as a result of either acts or omissions of the customer. The Company will not be liable for any consequential

loss or damage, whether due to its negligence or otherwise. The Company will not be liable to the customer for the Company's failure to comply with its obligations to the customer due to any cause beyond the Company's reasonable control and the Company's obligations affected by such cause are suspended while the cause continues to prevent or hinder the Company's performance.

ADVISORY NOTE

Considerable damage can occur during the delivery of doors particularly to country areas. "Special Packaging" is recommended (optional extra cost) in an attempt to prevent transit damage. The Company is not responsible for any transit damage.

INTERPRETATION OF WARP

Warp shall be interpreted as meaning the cupping/bowing or twisting of doors. It refers to distortion within the door itself and not its relationship to the jambs or frame in which it is hung. Warp of 4mm or less for doors up to 2150mm high and 6mm or less for door heights between 2150mm and 2400mm shall not be considered a defect. Doors over 2400mm high or 1020mm wide are not guaranteed against warp.

EXCLUSIONS

The guarantee against warp does not apply to the following:

- Doors with face veneers of different species.
- Doors that are improperly hung or do not swing freely.
- External flush doors which have been painted or stained dark colours, or different colours each face.

Experience has demonstrated that when warp occurs after doors have been delivered to storage or building sites, it is usually due to improper storage or adverse moisture conditions after hanging and not to faulty manufacture. The Company will accept no responsibility for doors when moisture content of the timber falls below 12% or exceeds 18%. The Company will not accept responsibility for conditions wholly beyond its control. However, the Company should be consulted promptly if excessive warping occurs to provide assistance in overcoming the difficulty.



STEEL DOOR FRAME WARRANTY

Subject to terms and conditions set forth herein, steel door frames manufactured and/or supplied by: Hume Doors & Timber (Aust) Pty. Ltd., Hume Doors & Timber (Qld) Pty. Ltd., Hume Doors & Timber (Vic) Pty. Ltd., Hume Doors & Timber (SA) Pty. Ltd. or Hume Doors & Timber (WA) Pty. Ltd. (hereinafter referred to as "the Company") are warranted by the manufacturer and/or supplier for one year from the date of shipment by the manufacturer and/or supplier to be of good material and workmanship, free from defects which render them unserviceable or unfit for the use for which they were manufactured.

THE COMPANY WARRANTS:

- Goods manufactured and/or supplied for a period of one (1) year as from the date of shipment, to be free from defects in material and workmanship which would render them unserviceable or unfit for normal use.
- To the extent permitted by law or the express provision of any statute or otherwise hereby expressly excluded and in respect warranties that cannot be so excluded, these terms and conditions shall be read such that those statutory warranties are read as being in addition to the warranties hereby given.
- Subject to Clause 2, the warranty in Clause 1 shall be read subject to the following matters being excluded as defects:

- Frames not accorded reasonable treatment by the customer.
- Damage or defects arising out of, or in connection with, shipment or storage after frames leave the control of the company (i.e. delivered to site or handed over to a carrier). Frames must be inspected by the customer for visible defects immediately upon delivery.
- Claims for non conforming deliveries (incomplete defective or incorrectly supplied) will only be considered if made within 3 working days of receipt or delivery of frames. All delivery checks are the responsibility of the customer.
- Under NO circumstance will the company be liable if frames are installed before checking that they are supplied correctly and are free from defects.
- Factory priming is only to protect frames in transport and general handling it is the responsibility of the customer to immediately on delivery of all frames apply 2 coats of compatible sealing priming to ensure corrosion or the like does not occur.
- It is the responsibility of the installer to ensure that the frames are installed plumb, square and suitably anchored using the correct fixing points.
- Storage and security of the frames is not the responsibility of the company.
- Stainless steel hinges are required to be maintained every 2 months to ensure prevention of tarnishing and corrosion.



OVERHEAD PROTECTION

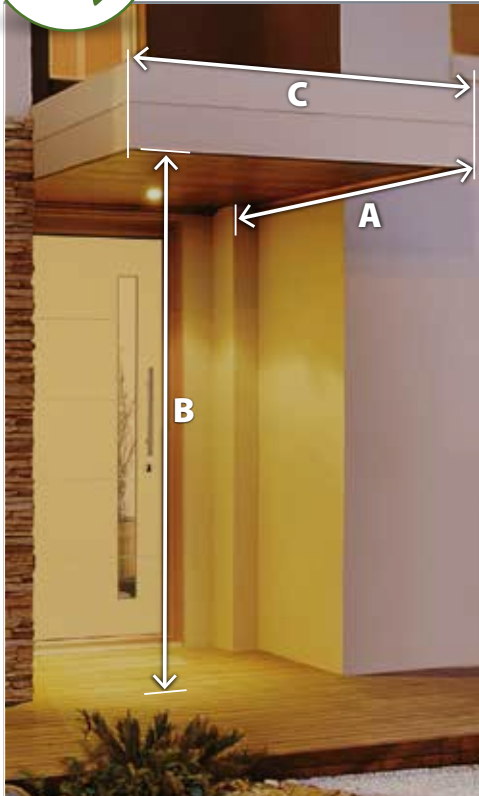

With Australia's climate extremes entrance doors will weather differently and timber doors are more susceptible to the elements than steel, aluminium or fibreglass doors.

Depending on your location and aspect the required overhead protection will vary. Tropical areas generally requiring more overhang than southern states.

The chart below will assist in determining the size of overhead protection which will vary depending on home design and adjacent walls. Dimension 'C' – subject to adjacent walls – minimum width same width as entry frame

NOTE: colour choice for your exterior door will also affect weathering. Dark colours absorb heat, accelerating door deterioration, warping and bowing. For door guarantee refer page 66.

OVERHEAD PROTECTION CALCULATION				
Climate	North	South	East	West
Coastal	A = 1/2 B	A = B	A = 1/2 B	A = B
Tropical	A = B	A = B	A = B	A = B
Arid	A = B	A = 1/2 B	A = B	A = 1/2 B
Mild	A = 1/2 B	A = 1/2 B	A = 1/2 B	A = B



CARE & MAINTENANCE

- Your timber door may be affected by changes in temperature, moisture and location. After selecting and purchasing your Hume door, store flat in a dry, well-ventilated area before installation.
- Before fitting the door, all six door surfaces should be sealed initially then after installation painted, stained or clear finished with good quality products. Follow the paint manufacturer's instructions with the correct number of coats on ALL surfaces.
- Light reflective colours are recommended for Entrance Doors to reduce the possibility of bow, twist or warp. Dark colours will void Hume guarantee. Semi-gloss finishes are recommended. Paint with a light reflectance value (LRV) finish greater than 50 should be used on external doors. See table below.

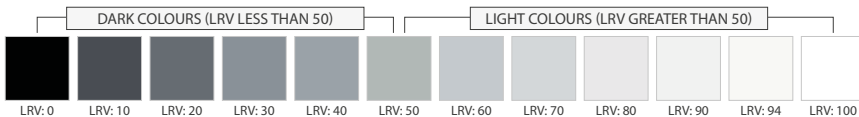

- Use the same colour on all six door surfaces. Different colours may cause doors to warp.
- Entrance Doors require overhead protection.
- Location and fitting of your door furniture can depend on door construction. Solid doors (rated for BAL12.5, BAL19, BAL29 & BAL40) may have door furniture installed at any selected height, either side of the door.
- Door maintenance is necessary for long term performance and periodic inspections are recommended. At the first signs of deterioration, your door should be properly refinished. Make sure that all surfaces of the door receive proper resealing and painting.
- To clean your door, use a damp cloth. Do not hose or use chemicals or abrasives on your door. Lightly oil hinges and door furniture for optimum performance.
- Contact your nearest Hume Doors stockist or the Hume Doors website for more information.



HUME HOW TO
WE MAKE IT EASY

Scan QR code for DIY videos

CONTACT DETAILS



HUME DOORS
& TIMBER

NEW SOUTH WALES



HUME DOORS & TIMBER – (AUST) PTY LTD
ABN 39 001 472 493

Sydney Office & Showroom
120 Hume Highway, Lansvale NSW 2166
PO Box 333, Cabramatta NSW 2166
P | 02 9794 1111
E | info@humedoors.com.au

Port Macquarie Branch
No. 2 Belah Road, Port Macquarie NSW
2444
P | 02 6581 0011
E | pmsales@humedoors.com.au

Newcastle Branch
7 Waterloo Avenue, Thornton NSW 2322
P | 02 4966 8880
E | nclsales@humedoors.com.au

QUEENSLAND



HUME DOORS & TIMBER (QLD) PTY LTD
ABN 25 009 994 996

86 – 92 Mudgee Street, Kingston QLD 4114
PO Box 2243, Logan City D.C. Qld 4114
P | 07 3489 6200
E | sales@humedoorsqld.com.au

Cairns Branch
4-6 Ponzo Street, Woree, QLD 4868
P | 07 4041 2099
E | hdtcairns@humedoorsqld.com.au

Sunshine Coast Branch
14 Junction Drive, Coolum Beach Qld 4573
P | 07 5446 2640
E | hdtcoolum@humedoorsqld.com.au

Northern Territory Branch
3 Adams Road (Cnr Beresford),
Yarrowonga NT 0830
P | 08 8932 3733
E | hdtnt@humedoorsqld.com.au

VICTORIA



HUME DOORS & TIMBER (VIC) PTY LTD
ABN 87 006 329 906

33 Remington Drive, South Dandenong VIC 3175
PO Box 4236, South Dandenong VIC 3164
P | 03 9799 6888
E | hdtvic@humedoors.com.au

Tasmanian Branch
5 Trotters Lane, Prospect Tasmania 7250
PO Box 393, Prospect Tasmania 7250
P | 03 6774 9100
E | tassales@humedoors.com.au

SOUTH AUSTRALIA



HUME DOORS & TIMBER (SA) PTY LTD
ABN 34 007 512 209

89 Heaslip Road, Burton SA 5110
PO Box 2037, Salisbury Downs SA 5108
P | 08 8280 2000
E | hdtisa@humedoors.com.au

WESTERN AUSTRALIA



HUME DOORS & TIMBER (WA) PTY LTD
ABN 62 009 421 569

75 Briggs Street, Carlisle WA 6101
PO Box 118, Welshpool WA 6986
P | 08 9470 1800
E | hdtwa@humedoors.com.au

“Disclaimer: Hume Doors & Timber reserves the right to alter or amend without prior notice, any data, dimensions and design details specified herein. Photographs or illustrations may not depict the exact design or specification and may vary to the actual product. Timber is a natural material and colour, texture and grain variation can occur. These are not considered defects. Doors are supplied unfinished unless otherwise specified and routed doors have exposed MDF.”